

TPS70445, TPS70448, TPS70451, TPS70458, TPS70402 DUAL-OUTPUT LOW-DROPOUT VOLTAGE REGULATORS WITH INTEGRATED SVS FOR SPLIT VOLTAGE SYSTEMS

SLVS307B – SEPTEMBER 2000 – REVISED APRIL 2003

- Dual Output Voltages for Split-Supply Applications
- Independent Enable Functions (See Part Number TPS703xx for Sequenced Outputs)
- Output Current Range of 1 A on Regulator 1 and 2 A on Regulator 2
- Fast Transient Response
- Voltage Options Are 3.3-V/2.5-V, 3.3-V/1.8-V, 3.3-V/1.5-V, 3.3-V/1.2-V, and Dual Adjustable Outputs
- Open Drain Power-On Reset With 120-ms Delay
- Open Drain Power Good for Regulator 1 and Regulator 2
- Ultralow 185 μ A (typ) Quiescent Current
- 2 μ A Input Current During Standby
- Low Noise: 78 μ V_{RMS} Without Bypass Capacitor
- Quick Output Capacitor Discharge Feature
- One Manual Reset Input
- 2% Accuracy Over Load and Temperature
- Undervoltage Lockout (UVLO) Feature
- 24-Pin PowerPAD™ TSSOP Package
- Thermal Shutdown Protection

description

The TPS704xx family of devices consists of dual-output low-dropout voltage regulators with integrated SVS (RESET, POR, or power on reset) and power good (PG) functions. These devices are capable of supplying 1 A and 2 A by regulator 1 and regulator 2 respectively. Quiescent current is typically 185 μ A at full load. Differentiated features, such as accuracy, fast transient response, SVS supervisory circuit (power on reset), manual reset input, and independent enable functions provide a complete system solution.

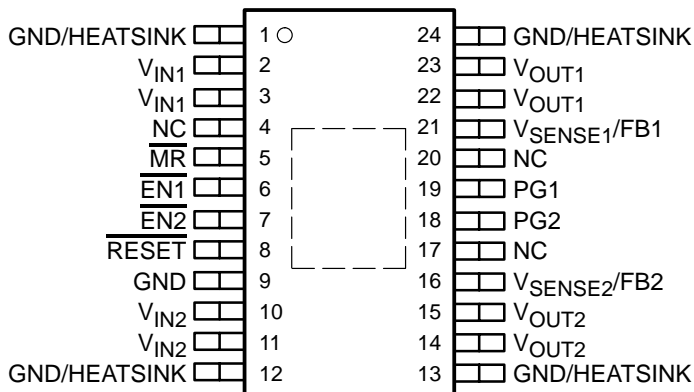

NC – No internal connection

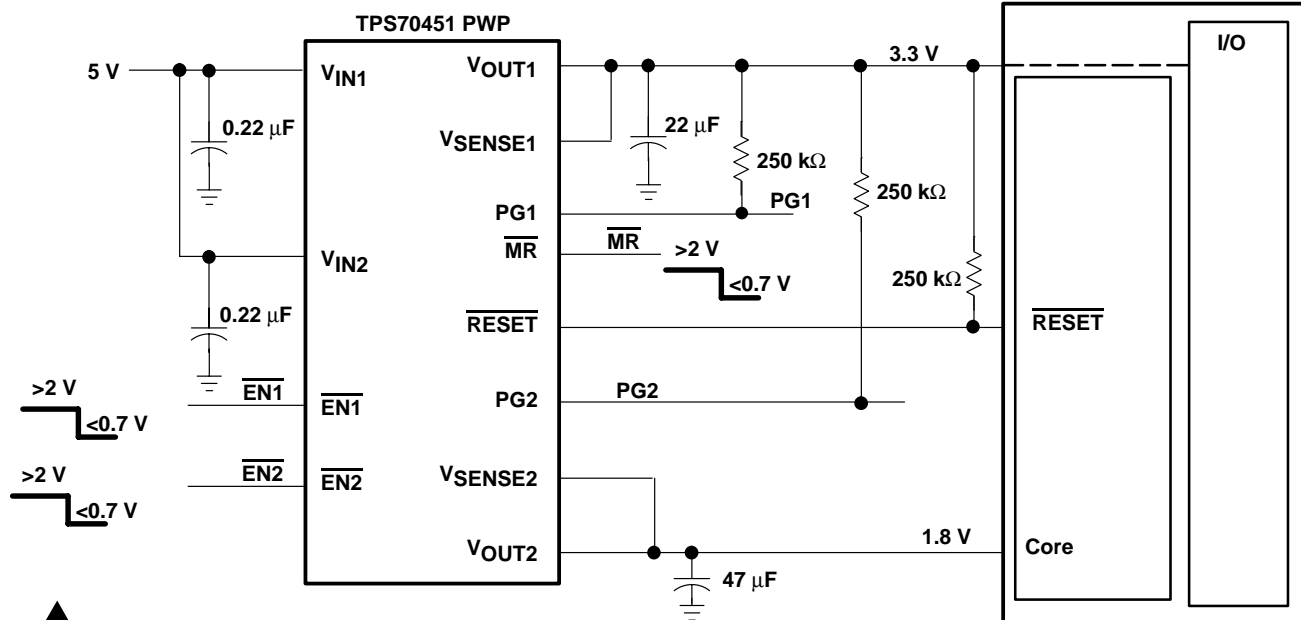

Please be aware that an important notice concerning availability, standard warranty, and use in critical applications of Texas Instruments semiconductor products and disclaimers thereto appears at the end of this data sheet.

PowerPAD is a trademark of Texas Instruments.

PRODUCTION DATA information is current as of publication date. Products conform to specifications per the terms of Texas Instruments standard warranty. Production processing does not necessarily include testing of all parameters.



POST OFFICE BOX 655303 • DALLAS, TEXAS 75265

Copyright © 2000, – 2003 Texas Instruments Incorporated

TPS70445, TPS70448, TPS70451, TPS70458, TPS70402 DUAL-OUTPUT LOW-DROPOUT VOLTAGE REGULATORS WITH INTEGRATED SVS FOR SPLIT VOLTAGE SYSTEMS

SLVS307B – SEPTEMBER 2000 – REVISED APRIL 2003

description (continued)

The TPS704xx family of voltage regulators offers very low dropout voltage and dual outputs. These devices have extremely low noise output performance without using any added filter bypass capacitors and are designed to have a fast transient response and be stable with 47 μ F low ESR capacitors.

These devices have fixed 3.3-V/2.5-V, 3.3-V/1.8-V, 3.3-V/1.5-V, 3.3-V/1.2-V, and adjustable voltage options. Regulator 1 can support up to 1 A, and regulator 2 can support up to 2 A. Separate voltage inputs allow the designer to configure the source power.

Because the PMOS pass element behaves as a low-value resistor, the dropout voltage is very low (typically 160 mV on regulator 1) and is directly proportional to the output current. Additionally, since the PMOS pass element is a voltage-driven device, the quiescent current is very low and independent of output loading (maximum of 250 μ A over the full range of output current and full range of temperature). This LDO family also features a sleep mode; applying a high signal to $\overline{EN1}$ or $\overline{EN2}$ (enable) shuts down regulator 1 or regulator 2, respectively. When a high signal is applied to both $\overline{EN1}$ and $\overline{EN2}$, both regulators are in sleep mode, thereby reducing the input current to 2 μ A at $T_J = 25^\circ\text{C}$.

For each regulator, there is an internal discharge transistor to discharge the output capacitor when the regulator is turned off (disabled).

The PG1 pin reports the voltage condition at V_{OUT1} . The PG1 pin can be used to implement a SVS (\overline{RESET} , POR, or power on reset) for the circuitry supplied by regulator 1. The PG2 pin reports the voltage conditions at V_{OUT2} . The PG2 pin can be used to implement a SVS (power on reset) for the circuitry supplied by regulator 2.

The TPS704xx features a \overline{RESET} (SVS, POR, or power on reset). \overline{RESET} is an active low, open drain output and requires a pullup resistor for normal operation. When pulled up, \overline{RESET} goes into a high impedance state (i.e. logic high) after 120 ms delay when both of the following conditions are met. First, V_{IN1} must be above the undervoltage condition. Second, the manual reset (\overline{MR}) pin must be in a high impedance state. To monitor V_{OUT1} , the PG1 output pin can be connected to \overline{MR} . To monitor V_{OUT2} , the PG2 output pin can be connected to \overline{MR} . \overline{RESET} can be used to drive power on reset or a low-battery indicator. If \overline{RESET} is not used, it can be left floating.

Internal bias voltages are powered by V_{IN1} and require 2.7 V for full functionality. Each regulator input has an undervoltage lockout circuit that prevents each output from turning on until the respective input reaches 2.5 V.

AVAILABLE OPTIONS

| T_J | REGULATOR 1 V_O (V) | REGULATOR 2 V_O (V) | TSSOP (PWP) |
|----------------|---------------------------------|---------------------------------|----------------|
| -40°C to 125°C | 3.3 V | 1.2 V | TPS70445PWP |
| | 3.3 V | 1.5 V | TPS70448PWP |
| | 3.3 V | 1.8 V | TPS70451PWP |
| | 3.3 V | 2.5 V | TPS70458PWP |
| | Adjustable (1.22 V to 5.5 V) | Adjustable (1.22 V to 5.5 V) | TPS70402PWP |

NOTE: The TPS70402 is programmable using external resistor dividers (see application information) The PWP package is available taped and reeled. Add an R suffix to the device type (e.g., TPS70402PWPR).



TPS70445, TPS70448, TPS70451, TPS70458, TPS70402 DUAL-OUTPUT LOW-DROPOUT VOLTAGE REGULATORS WITH INTEGRATED SVS FOR SPLIT VOLTAGE SYSTEMS

SLVS307B – SEPTEMBER 2000 – REVISED APRIL 2003

detailed block diagram – fixed voltage version

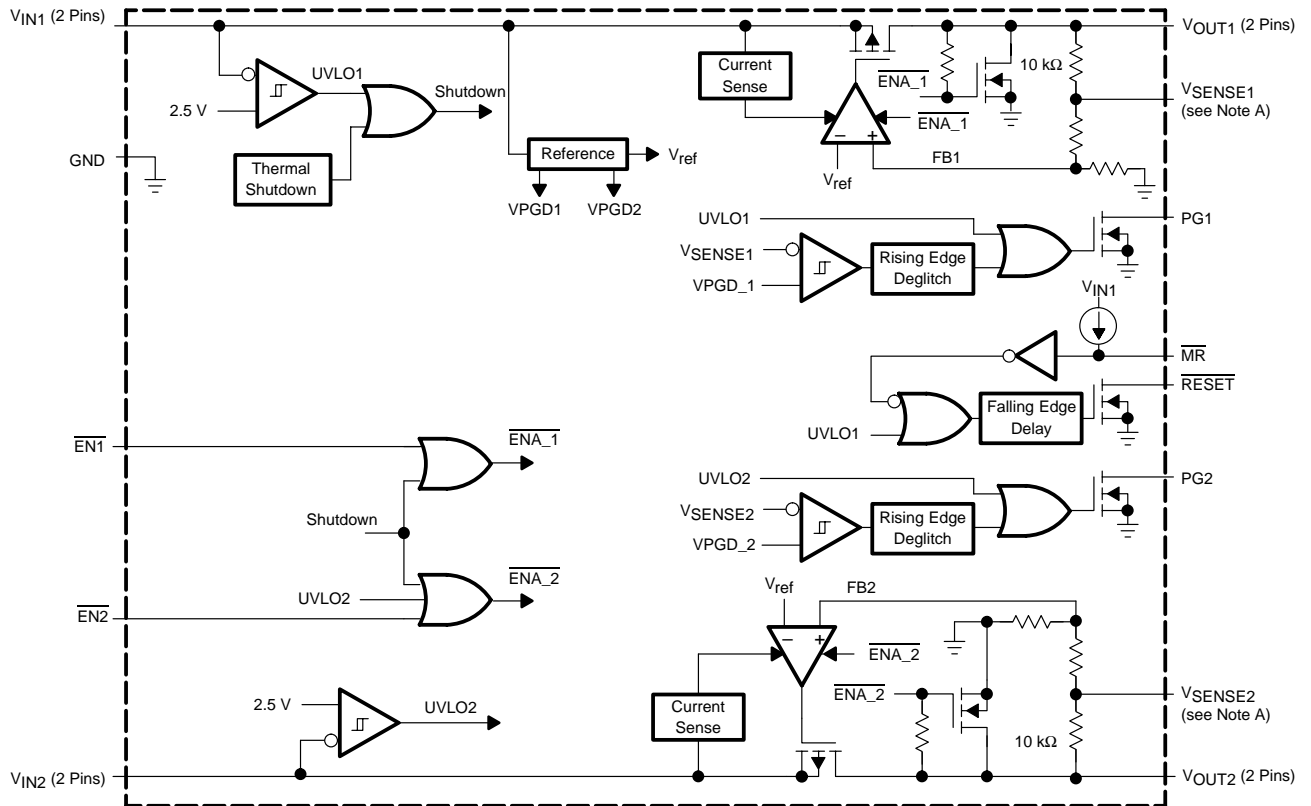

NOTE A: For most applications, V_{SENSE1} and V_{SENSE2} should be connected to V_{OUT1} and V_{OUT2} respectively as close as possible to the device. For other implementations, refer to SENSE terminal connection discussion in the application information section.

TPS70445, TPS70448, TPS70451, TPS70458, TPS70402 DUAL-OUTPUT LOW-DROPOUT VOLTAGE REGULATORS WITH INTEGRATED SVS FOR SPLIT VOLTAGE SYSTEMS

SLVS307B – SEPTEMBER 2000 – REVISED APRIL 2003

detailed block diagram – adjustable voltage version

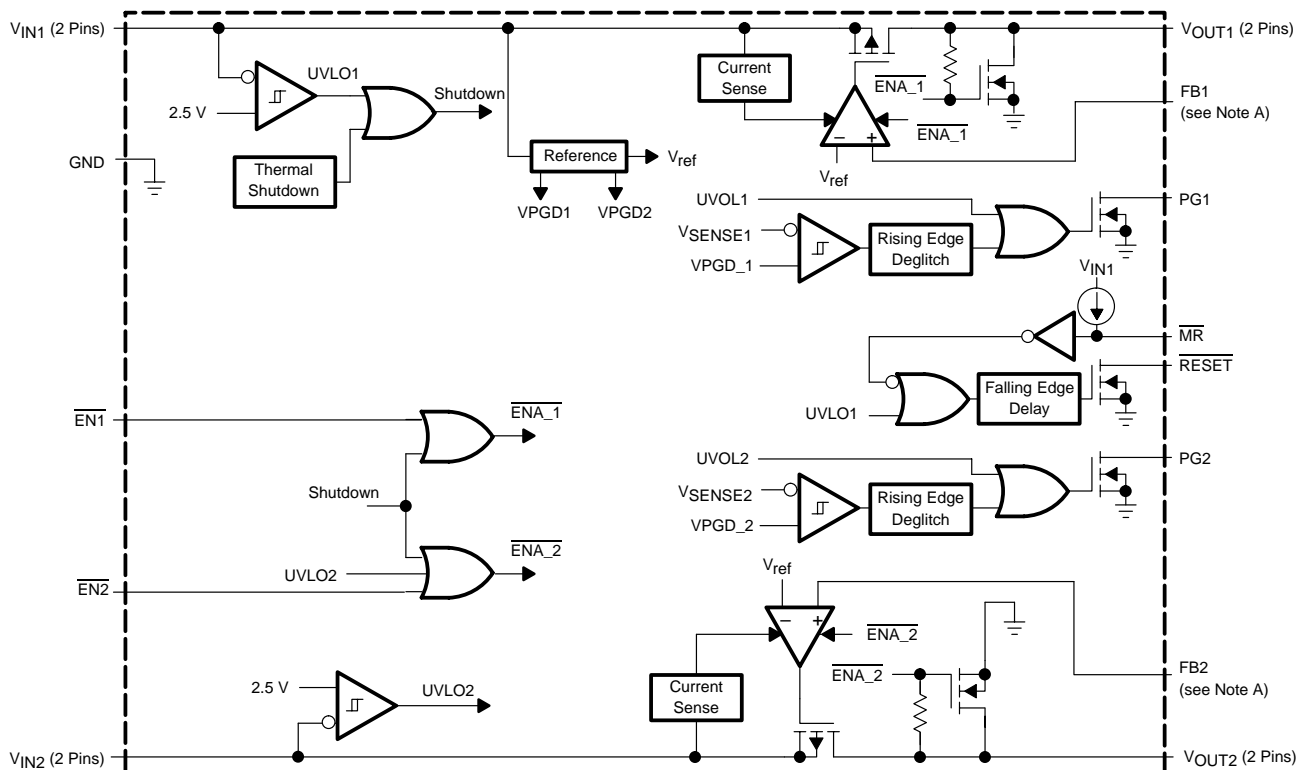

NOTE A: For most applications, FB1 and FB2 should be connected to resistor dividers as close as possible to the device. For other implementations, refer to FB terminals connection discussion in the application information section.

TPS70445, TPS70448, TPS70451, TPS70458, TPS70402
 DUAL-OUTPUT LOW-DROPOUT VOLTAGE REGULATORS
 WITH INTEGRATED SVS FOR SPLIT VOLTAGE SYSTEMS

SLVS307B – SEPTEMBER 2000 – REVISED APRIL 2003

RESET timing diagram

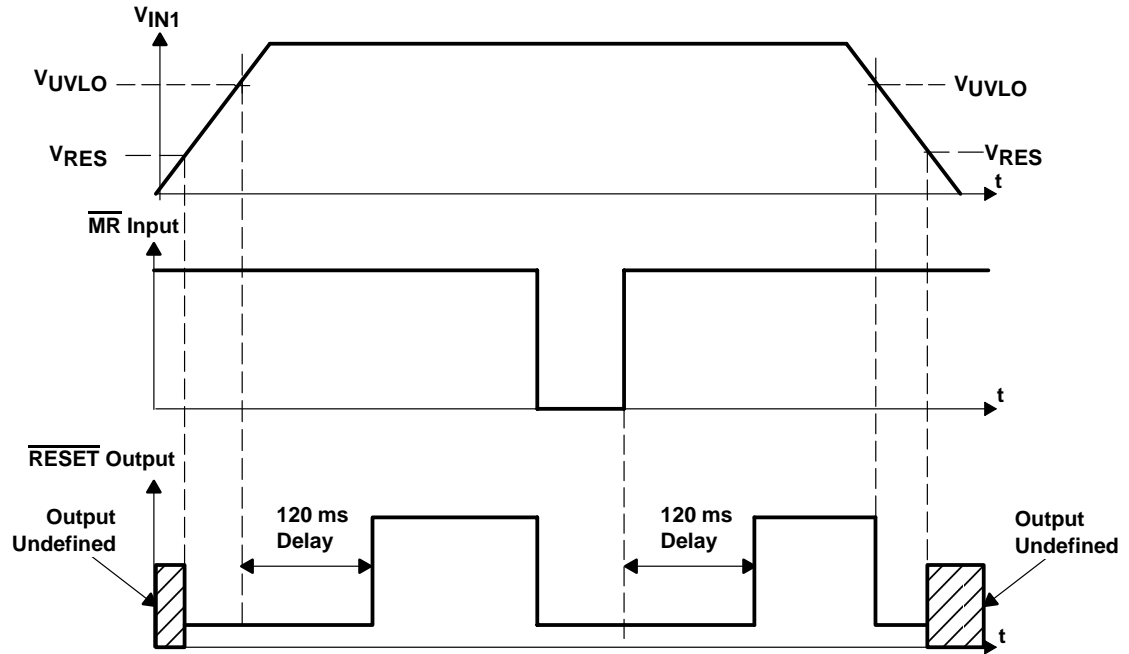

NOTES: A. V_{RES} is the minimum input voltage for a valid \overline{RESET} . The symbol V_{RES} is not currently listed within EIA or JEDEC standards for semiconductor symbology.

PG1 timing diagram

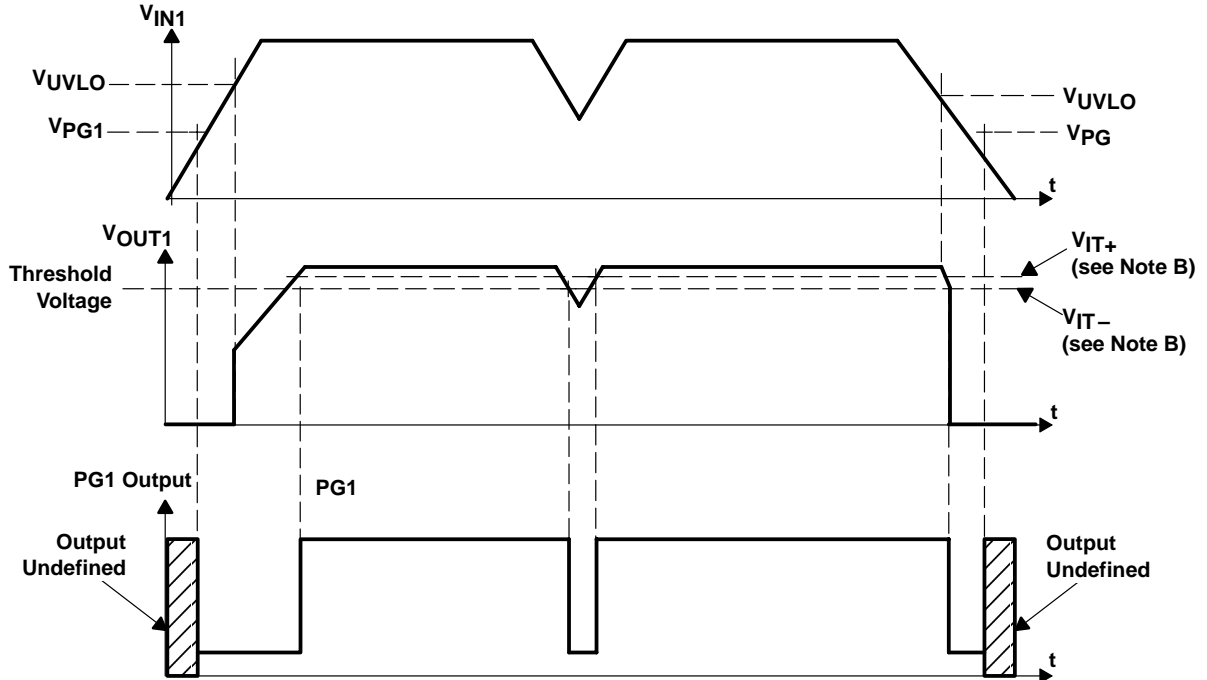

NOTES: A. V_{PG1} is the minimum input voltage for a valid $PG1$. The symbol V_{PG1} is not currently listed within EIA or JEDEC standards for semiconductor symbology.

B. V_{IT-} —Trip voltage is typically 5% lower than the output voltage ($95\%V_O$) V_{IT-} to V_{IT+} is the hysteresis voltage.

TPS70445, TPS70448, TPS70451, TPS70458, TPS70402
DUAL-OUTPUT LOW-DROPOUT VOLTAGE REGULATORS
WITH INTEGRATED SVS FOR SPLIT VOLTAGE SYSTEMS

SLVS307B – SEPTEMBER 2000 – REVISED APRIL 2003

PG2 timing diagram (assuming V_{IN1} already powered up)

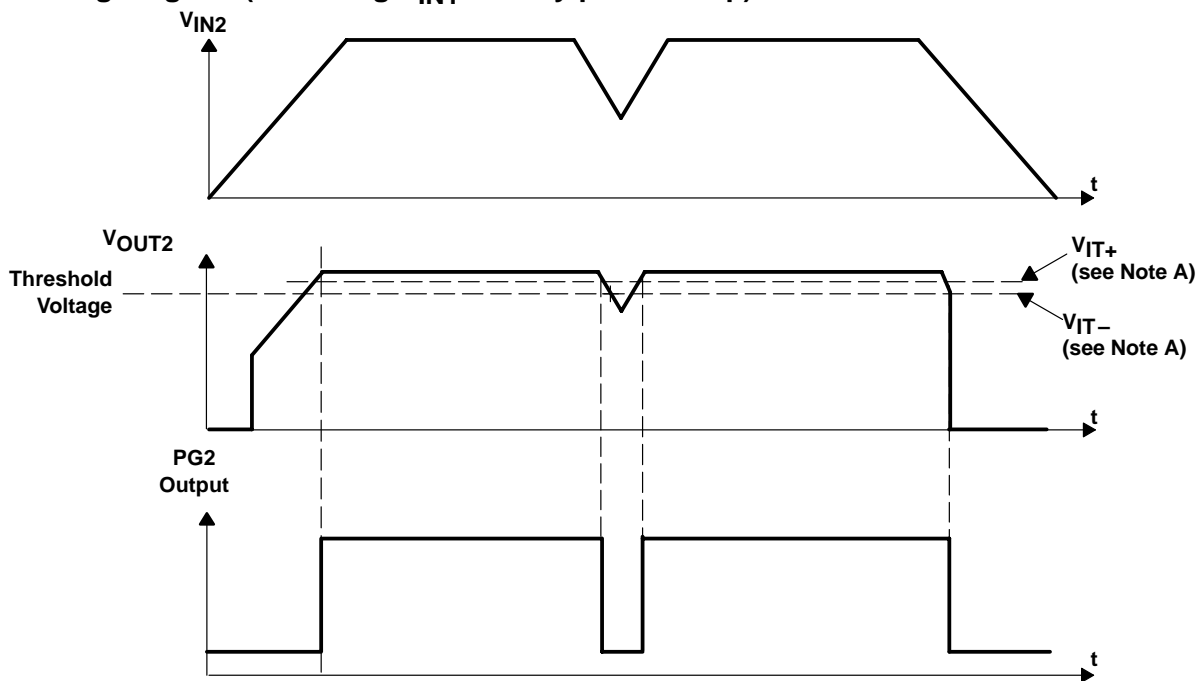

NOTES: A. V_{IT-} – Trip voltage is typically 5% lower than the output voltage ($95\%V_O$) V_{IT-} to V_{IT+} is the hysteresis voltage.

Terminal Functions

| TERMINAL NAME | NO. | I/O | DESCRIPTION |
|--------------------|---------------|-----|--|
| $\overline{EN1}$ | 6 | I | Active low enable for V_{OUT1} |
| $\overline{EN2}$ | 7 | I | Active low enable for V_{OUT2} |
| GND | 9 | | Ground |
| GND/HEATSINK | 1, 12, 13, 24 | | Ground/heatsink |
| \overline{MR} | 5 | I | Manual reset input, active low, pulled up internally |
| NC | 4, 17, 20 | | No connection |
| PG1 | 19 | O | Open drain output, low when V_{OUT1} voltage is less than 95% of the nominal regulated voltage |
| PG2 | 18 | O | Open drain output, low when V_{OUT2} voltage is less than 95% of the nominal regulated voltage |
| \overline{RESET} | 8 | O | Open drain output, SVS (power on reset) signal, active low |
| V_{IN1} | 2, 3 | I | Input voltage of regulator 1 |
| V_{IN2} | 10, 11 | I | Input voltage of regulator 2 |
| V_{OUT1} | 22, 23 | O | Output voltage of regulator 1 |
| V_{OUT2} | 14, 15 | O | Output voltage of regulator 2 |
| $V_{SENSE1}/FB1$ | 21 | I | Regulator 1 output voltage sense/ regulator 1 feedback for adjustable |
| $V_{SENSE2}/FB2$ | 16 | I | Regulator 2 output voltage sense/ regulator 2 feedback for adjustable |



detailed description

The TPS704xx low dropout regulator family provides dual regulated output voltages with independent enable functions. These devices provide fast transient response and high accuracy with small output capacitors, while drawing low quiescent current. Other features are integrated SVS (power-on reset, $\overline{\text{RESET}}$) and power good (PG1, PG2) that monitor output voltages and provide logic output to the system. These differentiated features provide a complete power solution.

The TPS704xx, unlike many other LDOs, features very low quiescent current which remains virtually constant even with varying loads. Conventional LDO regulators use a PNP pass element, the base current of which is directly proportional to the load current through the regulator ($I_B = I_C/\beta$). The TPS704xx uses a PMOS transistor to pass current; because the gate of the PMOS is voltage driven, operating current is low and stable over the full load range.

pin functions

enable ($\overline{\text{EN1}}$ and $\overline{\text{EN2}}$)

The $\overline{\text{EN}}$ terminals are inputs which enable or shut down each respective regulator. If $\overline{\text{EN}}$ is at a logic high, the respective regulator will be in shutdown mode. When $\overline{\text{EN}}$ goes to voltage low, then the respective regulator is enabled.

power good (PG1 and PG2)

The PG terminals are open drain, active high outputs which indicate the status of each respective regulator. When the V_{OUT1} reaches 95% of its regulated voltage, PG1 will go to a high impedance state. When the V_{OUT2} reaches 95% of its regulated voltage, PG2 goes to a high impedance state. Each PG goes to a low impedance state when its respective output voltage is pulled below 95% (i.e., over load condition) of its regulated voltage. The open drain outputs of the PG terminals require a pullup resistor.

manual reset pin ($\overline{\text{MR}}$)

$\overline{\text{MR}}$ is an active low input terminal used to trigger a reset condition. When $\overline{\text{MR}}$ is pulled to logic low, a POR ($\overline{\text{RESET}}$) occurs. The terminal has a 6- μA pullup current to V_{IN1} ; however, it is recommended that the pin be pulled high to V_{IN1} when it is not used.

sense (V_{SENSE1} , V_{SENSE2})

The sense terminals of fixed-output options must be connected to the regulator outputs, and the connection should be as short as possible. Internally, the sense terminal connects to high-impedance wide-bandwidth amplifiers through a resistor-divider network and noise pickup feeds through to the regulator output. It is essential to route the sense connection in such a way as to minimize/avoid noise pickup. Adding RC networks between sense terminals and V_{OUT} terminals to filter noise is not recommended because it can cause the regulators to oscillate.

FB1 and FB2

FB1 and FB2 are input terminals used for adjustable-output devices and must be connected to the external feedback resistor divider. FB1 and FB2 connections should be as short as possible. It is essential to route them in such a way as to minimize/avoid noise pickup. Adding RC networks between FB terminals and V_{OUTS} to filter noise is not recommended because it can cause the regulators to oscillate.

$\overline{\text{RESET}}$ indicator

$\overline{\text{RESET}}$ is an active low, open drain output and requires a pullup resistor for normal operation. When pulled up, $\overline{\text{RESET}}$ goes into a high impedance state (i.e. logic high) after a 120 ms delay when both of the following conditions are met. First, V_{IN1} must be above the undervoltage condition. Second, the manual reset (MR) pin must be in a high impedance state. To monitor V_{OUT1} , the PG1 output pin can be connected to $\overline{\text{MR}}$. To monitor V_{OUT2} , the PG2 output pin can be connected to $\overline{\text{MR}}$. If $\overline{\text{RESET}}$ is not used, it can be left floating.

TPS70445, TPS70448, TPS70451, TPS70458, TPS70402 DUAL-OUTPUT LOW-DROPOUT VOLTAGE REGULATORS WITH INTEGRATED SVS FOR SPLIT VOLTAGE SYSTEMS

SLVS307B – SEPTEMBER 2000 – REVISED APRIL 2003

detailed description (continued)

V_{IN1} and V_{IN2}

V_{IN1} and V_{IN2} are inputs to each regulator. Internal bias voltages are powered by V_{IN1} .

V_{OUT1} and V_{OUT2}

V_{OUT1} and V_{OUT2} are output terminals of each regulator.

absolute maximum ratings over operating junction temperature (unless otherwise noted)†

| | |
|--|-------------------------------|
| Input voltage range‡: V_{IN1} | -0.3 V to 7 V |
| V_{IN2} | -0.3 V to 7 V |
| Voltage range at $\overline{EN1}$, $\overline{EN2}$ | -0.3 V to 7 V |
| Output voltage range (V_{OUT1} , V_{SENSE1}) | 5.5 V |
| Output voltage range (V_{OUT2} , V_{SENSE2}) | 5.5 V |
| Maximum RESET, PG1, PG2 voltage | 7 V |
| Maximum MR voltage | V_{IN1} |
| Peak output current | Internally limited |
| Continuous total power dissipation | See Dissipation Rating Tables |
| Operating virtual junction temperature range, T_J | -40°C to 150°C |
| Storage temperature range, T_{stg} | -65°C to 150°C |
| ESD rating, HBM | 2 kV |

† Stresses beyond those listed under “absolute maximum ratings” may cause permanent damage to the device. These are stress ratings only, and functional operation of the device at these or any other conditions beyond those indicated under “recommended operating conditions” is not implied. Exposure to absolute-maximum-rated conditions for extended periods may affect device reliability.

‡ All voltages are tied to network ground.

DISSIPATION RATING TABLE

| PACKAGE | AIR FLOW (CFM) | $T_A \leq 25^\circ\text{C}$ | DERATING FACTOR | $T_A = 70^\circ\text{C}$ | $T_A = 85^\circ\text{C}$ |
|---------|----------------|-----------------------------|-----------------|--------------------------|--------------------------|
| PWP§ | 0 | 3.32 W | 33.2 mW/°C | 1.83 W | 1.33 W |
| | 250 | 4.58 W | 45.87 mW/°C | 2.52 W | 1.83 W |

§ This parameter is measured with the recommended copper heat sink pattern on a 4-layer PCB, 2 oz. copper traces on 4-in × 4-in ground layer. Simultaneous and continuous operation of both regulator outputs at full load may exceed the power dissipation rating of the PWP package. For more information, refer to the power dissipation and thermal information section at the end of this data sheet, and to TI technical brief SLMA002.

recommended operating conditions

| | MIN | MAX | UNIT |
|---|------|-----|------|
| Input voltage, V_I † | 2.7 | 6 | V |
| Output current, I_O (regulator 1) | 0 | 1 | A |
| Output current, I_O (regulator 2) | 0 | 2 | A |
| Output voltage range (for adjustable option) | 1.22 | 5.5 | V |
| Operating virtual junction temperature, T_J | -40 | 125 | °C |

† To calculate the minimum input voltage for maximum output current, use the following equation: $V_{I(\min)} = V_{O(\max)} + V_{DO(\max \text{ load})}$.



TPS70445, TPS70448, TPS70451, TPS70458, TPS70402
DUAL-OUTPUT LOW-DROPOUT VOLTAGE REGULATORS
WITH INTEGRATED SVS FOR SPLIT VOLTAGE SYSTEMS

SLVS307B – SEPTEMBER 2000 – REVISED APRIL 2003

electrical characteristics over recommended operating junction temperature ($T_J = -40^\circ\text{C}$ to 125°C)
 V_{IN1} or $V_{IN2} = V_{OUTX(nom)} + 1\text{ V}$, $I_O = 1\text{ mA}$, $\overline{EN} = 0$, $C_{OUT1} = 22\mu\text{F}$, $C_{OUT2} = 47\mu\text{F}$ (unless otherwise noted)

| PARAMETER | | TEST CONDITIONS | MIN | TYP | MAX | UNIT | |
|---|--|--|-------|-------|-------|------------------|----|
| V_O | Reference voltage | $2.7\text{ V} < V_I < 6\text{ V}$ $T_J = 25^\circ\text{C}$ | | 1.22 | | V | |
| | | $2.7\text{ V} < V_I < 6\text{ V}$, FB connected to V_O | 1.196 | | 1.244 | | |
| | 1.2 V output (V_{OUT2}) | $2.7\text{ V} < V_I < 6\text{ V}$, $T_J = 25^\circ\text{C}$ | | 1.2 | | | |
| | 1.5 V output (V_{OUT2}) | $2.7\text{ V} < V_I < 6\text{ V}$, $T_J = 25^\circ\text{C}$ | 1.176 | | 1.224 | | |
| | 1.8 V output (V_{OUT2}) | $2.7\text{ V} < V_I < 6\text{ V}$, $T_J = 25^\circ\text{C}$ | | 1.5 | | | |
| | 2.5 V output (V_{OUT2}) | $2.7\text{ V} < V_I < 6\text{ V}$, $T_J = 25^\circ\text{C}$ | 1.47 | | 1.53 | | |
| | 3.3 V output (V_{OUT2}) | $2.7\text{ V} < V_I < 6\text{ V}$, $T_J = 25^\circ\text{C}$ | | 1.8 | | | |
| | 3.3 V output (V_{OUT2}) | $2.8\text{ V} < V_I < 6\text{ V}$, $T_J = 25^\circ\text{C}$ | 1.764 | | 1.836 | | |
| Quiescent current ($\overline{\text{GND}}$ current) for regulator 1 and regulator 2, $\overline{EN1} = \overline{EN2} = 0\text{ V}$, (see Note 1) | See Note 3, See Note 3 | $T_J = 25^\circ\text{C}$ | | 185 | | μA | |
| | | | | | 250 | | |
| Output voltage line regulation ($\Delta V_O/V_O$) for regulator 1 and regulator 2 (see Note 2) | $V_O + 1\text{ V} < V_I \leq 6\text{ V}$, $V_O + 1\text{ V} < V_I \leq 6\text{ V}$ | $T_J = 25^\circ\text{C}$, See Note 1 See Note 1 | | 0.01% | | V | |
| | | | | | 0.1% | | |
| Load regulation for V_{OUT1} and V_{OUT2} | | $T_J = 25^\circ\text{C}$ | | 1 | | mV | |
| V_n Output noise voltage (TPS70451) | Regulator 1 | BW = 300 Hz to 50 kHz, $T_J = 25^\circ\text{C}$ | | 79 | | μVrms | |
| | Regulator 2 | | | 77 | | | |
| Output current limit | Regulator 1 | $V_O = 0\text{ V}$ | | 1.75 | 2.2 | A | |
| | Regulator 2 | | | 3.8 | 4.5 | | |
| Thermal shutdown junction temperature | | | | 150 | | $^\circ\text{C}$ | |
| $I_{I(\text{standby})}$ Standby current | Regulator 1 and Regulator 2 | $\overline{EN1} = V_I$, $\overline{EN2} = V_I$, $T_J = 25^\circ\text{C}$ | | 1 | 2 | μA | |
| | | $\overline{EN1} = V_I$, $\overline{EN2} = V_I$ | | | 10 | | |
| PSRR Power supply ripple rejection (TPS70451) | Regulator 1 | $f = 1\text{ kHz}$, $T_J = 25^\circ\text{C}$, See Note 1 | | 65 | | dB | |
| | Regulator 2 | $f = 1\text{ kHz}$, $T_J = 25^\circ\text{C}$, See Note 1 | | 60 | | | |
| RESET terminal | | | | | | | |
| Minimum input voltage for valid $\overline{\text{RESET}}$ | | $I_{(\text{RESET})} = 300\mu\text{A}$, $V_{(\text{RESET})} \leq 0.8\text{ V}$ | | 1.0 | 1.3 | V | |
| $t_{(\text{RESET})}$ | | $\overline{\text{RESET}}$ pulse duration | | 80 | 120 | 160 | ms |
| Output low voltage | | $V_I = 3.5\text{ V}$, $I_{(\text{RESET})} = 1\text{ mA}$ | | 0.15 | 0.4 | V | |
| Leakage current | | $V_{(\text{RESET})} = 6\text{ V}$ | | | 1 | μA | |

NOTES: 1. Minimum input operating voltage is 2.7 V or $V_{O(\text{typ})} + 1\text{ V}$, whichever is greater. Maximum input voltage = 6 V, minimum output current 1 mA.

2. If $V_O < 1.8\text{ V}$ then $V_{I\text{max}} = 6\text{ V}$, $V_{I\text{min}} = 2.7\text{ V}$:

$$\text{Line regulation (mV)} = (\%/V) \times \frac{V_O(V_{I\text{max}} - 2.7\text{ V})}{100} \times 1000$$

If $V_O > 2.5\text{ V}$ then $V_{I\text{max}} = 6\text{ V}$, $V_{I\text{min}} = V_O + 1\text{ V}$:

$$\text{Line regulation (mV)} = (\%/V) \times \frac{V_O(V_{I\text{max}} - (V_O + 1))}{100} \times 1000$$

3. $I_O = 1\text{ mA}$ to 1 A for regulator 1 and 1 mA to 2 A for regulator 2.



TPS70445, TPS70448, TPS70451, TPS70458, TPS70402
DUAL-OUTPUT LOW-DROPOUT VOLTAGE REGULATORS
WITH INTEGRATED SVS FOR SPLIT VOLTAGE SYSTEMS

SLVS307B – SEPTEMBER 2000 – REVISED APRIL 2003

electrical characteristics over recommended operating junction temperature ($T_J = -40^\circ\text{C}$ to 125°C)
 V_{IN1} or $V_{IN2} = V_{OUTX(nom)} + 1\text{ V}$, $I_O = 1\text{ mA}$, $\overline{EN} = 0$, $C_{OUT1} = 22\mu\text{F}$, $C_{OUT2} = 47\mu\text{F}$ (unless otherwise noted)
 (continued)

| PARAMETER | TEST CONDITIONS | MIN | TYP | MAX | UNIT |
|--|--|-----|------|------|---------------|
| V_{IN1}/V_{IN2} terminal | | | | | |
| UVLO threshold | | 2.4 | | 2.65 | V |
| UVLO hysteresis | | | 110 | | mV |
| PG1/PG2 terminal | | | | | |
| Minimum input voltage for valid PGx | $I_{(PGx)} = 300\mu\text{A}$, $V_{(PGx)} \leq 0.8\text{ V}$ | | 1.0 | 1.3 | V |
| Trip threshold voltage | V_O decreasing | 92% | 95% | 98% | V_O |
| Hysteresis voltage | Measured at V_O | | 0.5% | | V_O |
| $t_r(PGx)$ | Rising edge deglitch | | 30 | | μs |
| Output low voltage | $V_I = 2.7\text{ V}$, $I_{(PGx)} = 1\text{ mA}$ | | 0.15 | 0.4 | V |
| Leakage current | $V_{(PGx)} = 6\text{ V}$ | | | 1 | μA |
| EN1/EN2 terminal | | | | | |
| High-level \overline{ENx} input voltage | | 2 | | | V |
| Low-level \overline{ENx} input voltage | | | | 0.7 | V |
| Input current (\overline{ENx}) | | -1 | | 1 | μA |
| MR terminal | | | | | |
| High-level input voltage | | 2 | | | V |
| Low-level input voltage | | | | 0.7 | V |
| Pullup current source | | | 6 | | μA |
| V_{OUT1} terminal | | | | | |
| Dropout voltage (see Note 4) | $I_O = 1\text{ A}$, $V_{IN1} = 3.2\text{ V}$, $T_J = 25^\circ\text{C}$ | | 160 | | mV |
| | $I_O = 1\text{ A}$, $V_{IN1} = 3.2\text{ V}$ | | | 250 | |
| Peak output current | 2 ms pulse width | | 1.2 | | A |
| Discharge transistor current | $V_{OUT1} = 1.5\text{ V}$ | | 7.5 | | mA |
| V_{OUT2} terminal | | | | | |
| Peak output current | 2 ms pulse width | | 3 | | A |
| Discharge transistor current | $V_{OUT2} = 1.5\text{ V}$ | | 7.5 | | mA |
| FB terminal | | | | | |
| Input current – TPS70402 | FB = 1.8 V | | | 1 | μA |

NOTE 4: Input voltage (V_{IN1} or V_{IN2}) = $V_O(\text{Typ}) - 100\text{ mV}$. For the 1.5-V, 1.8-V and 2.5-V regulators, the dropout voltage is limited by input voltage range. The 3.3 V regulator input voltage is set to 3.2 V to perform this test.



**TPS70445, TPS70448, TPS70451, TPS70458, TPS70402
DUAL-OUTPUT LOW-DROPOUT VOLTAGE REGULATORS
WITH INTEGRATED SVS FOR SPLIT VOLTAGE SYSTEMS**

SLVS307B – SEPTEMBER 2000 – REVISED APRIL 2003

TYPICAL CHARACTERISTICS

Table of Graphs

| | | | FIGURE |
|------------------|------------------------------------|-------------------------|---------|
| V_O | Output voltage | vs Output current | 1, 2 |
| | | vs Junction temperature | 3, 4 |
| | Ground current | vs Junction temperature | 5 |
| PSRR | Power supply rejection ratio | vs Frequency | 6 – 9 |
| | Output spectral noise density | vs Frequency | 10 – 13 |
| z_o | Output impedance | vs Frequency | 14 – 17 |
| | Dropout voltage | vs Temperature | 18, 19 |
| vs Input voltage | | 20, 21 | |
| | Load transient response | | 22, 23 |
| | Line transient response | | 24, 25 |
| V_O | Output voltage | vs Time (start-up) | 26, 27 |
| | Equivalent series resistance (ESR) | vs Output current | 29 – 32 |

**TPS70451
OUTPUT VOLTAGE
vs
OUTPUT CURRENT**

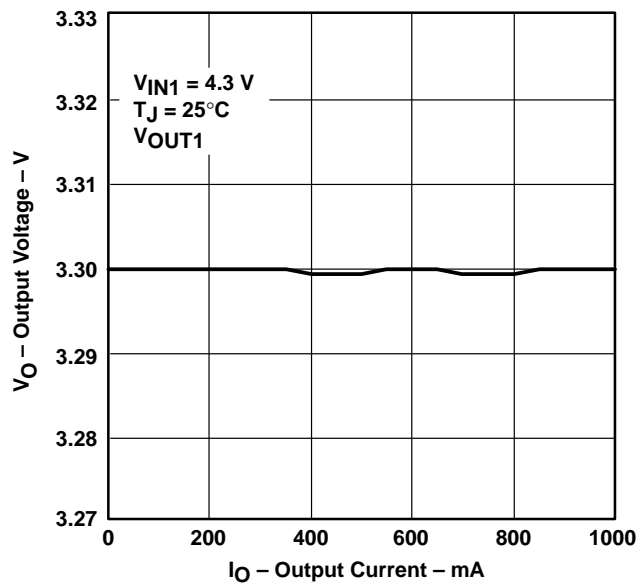

Figure 1

**TPS70451
OUTPUT VOLTAGE
vs
OUTPUT CURRENT**

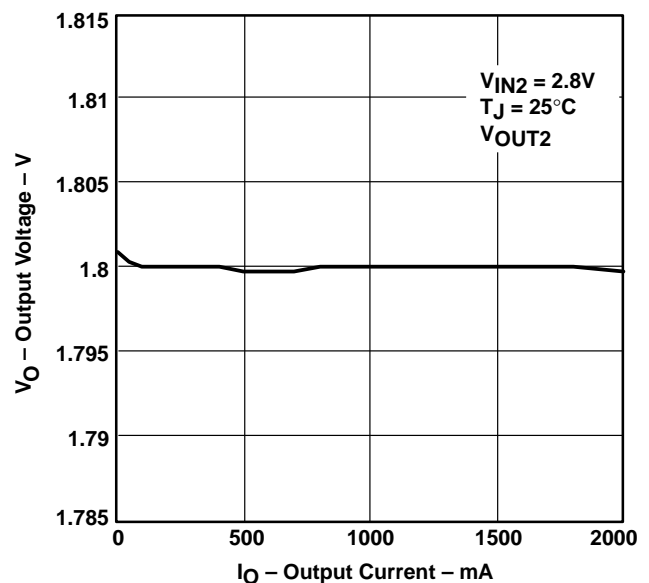

Figure 2

TPS70445, TPS70448, TPS70451, TPS70458, TPS70402
DUAL-OUTPUT LOW-DROPOUT VOLTAGE REGULATORS
WITH INTEGRATED SVS FOR SPLIT VOLTAGE SYSTEMS

SLVS307B – SEPTEMBER 2000 – REVISED APRIL 2003

TYPICAL CHARACTERISTICS

TPS70451
OUTPUT VOLTAGE
vs
JUNCTION TEMPERATURE

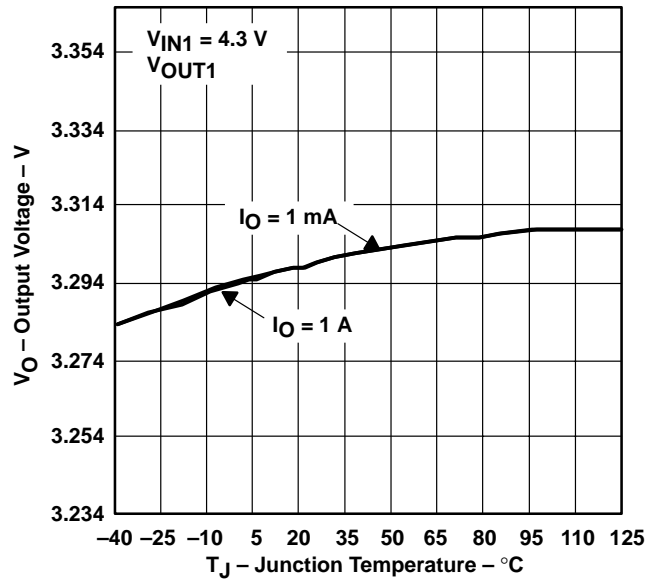

Figure 3

TPS70451
OUTPUT VOLTAGE
vs
JUNCTION TEMPERATURE

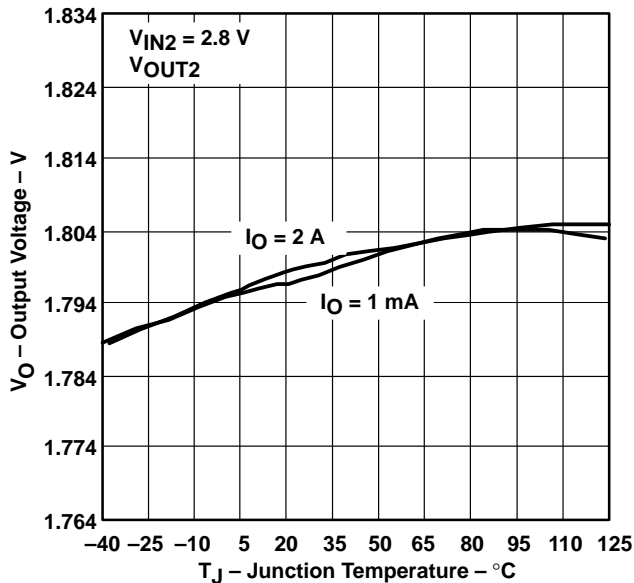

Figure 4

TPS70451
GROUND CURRENT
vs
JUNCTION TEMPERATURE

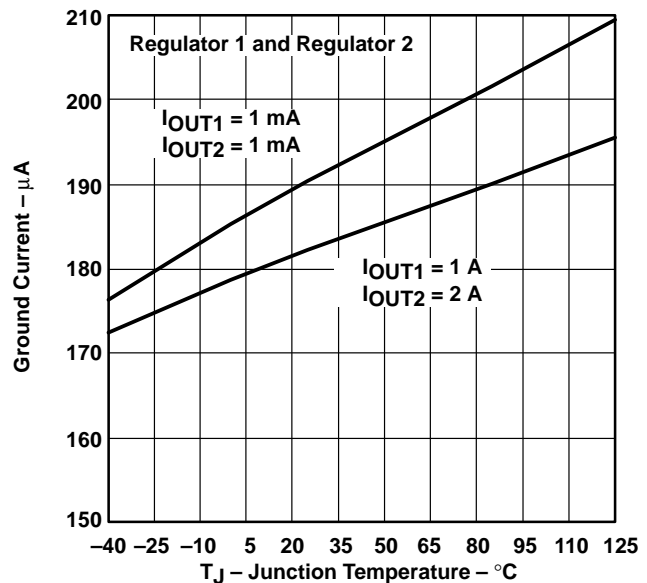

Figure 5



TPS70445, TPS70448, TPS70451, TPS70458, TPS70402
 DUAL-OUTPUT LOW-DROPOUT VOLTAGE REGULATORS
 WITH INTEGRATED SVS FOR SPLIT VOLTAGE SYSTEMS

SLVS307B – SEPTEMBER 2000 – REVISED APRIL 2003

TYPICAL CHARACTERISTICS

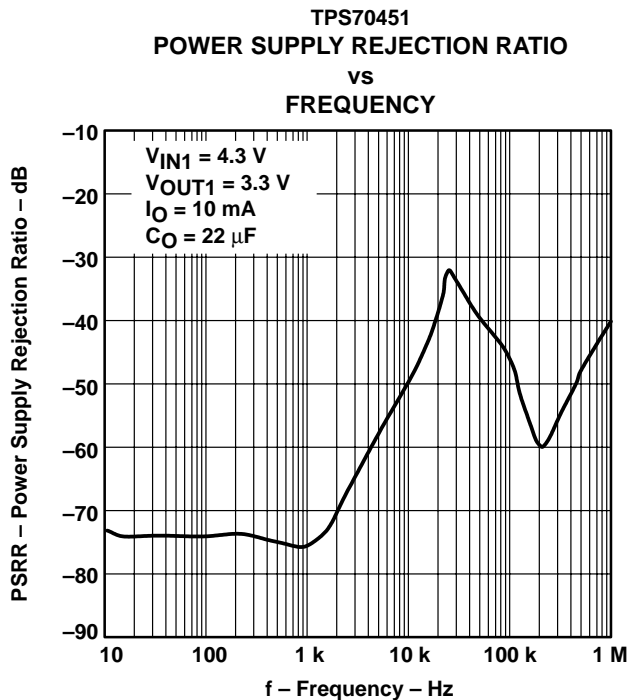

Figure 6

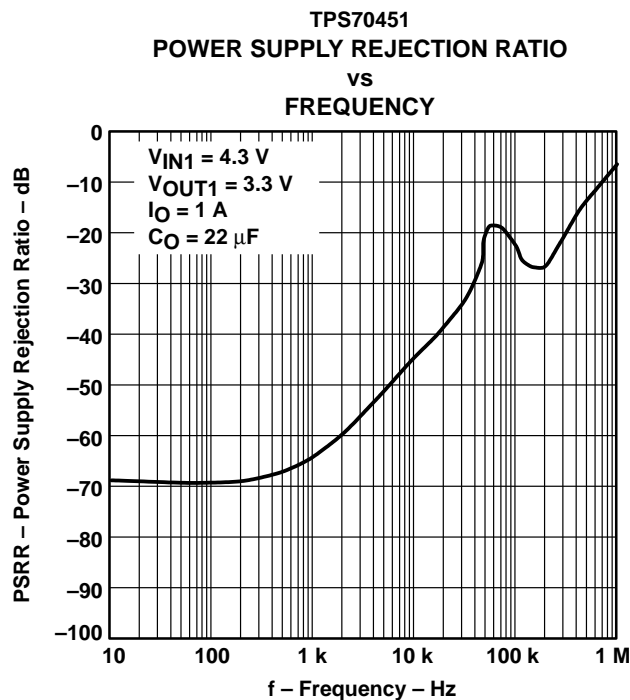

Figure 7

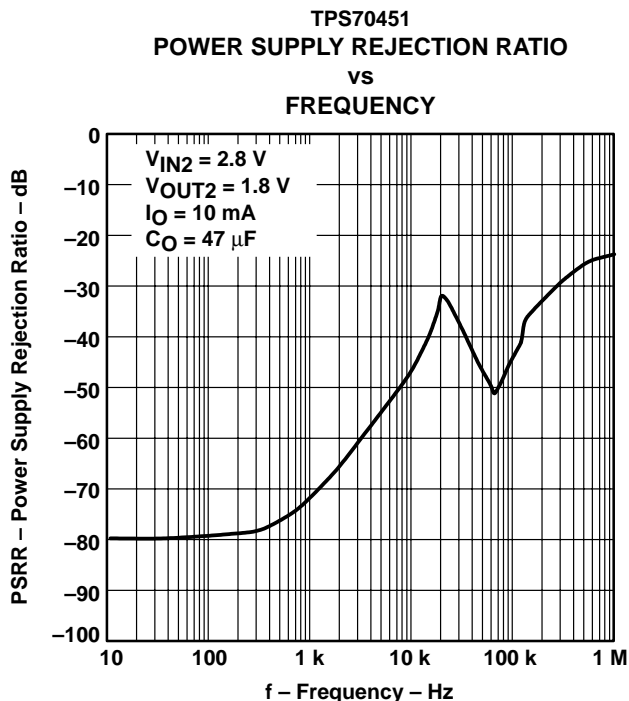

Figure 8

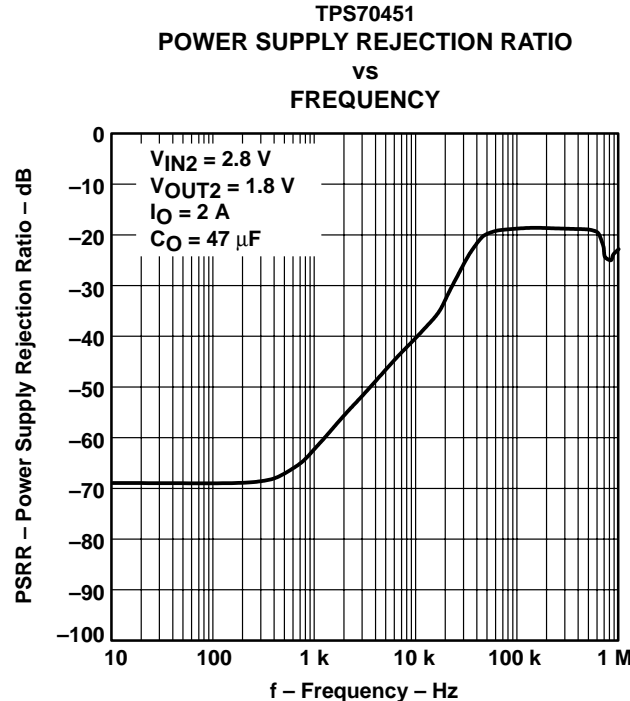

Figure 9

TPS70445, TPS70448, TPS70451, TPS70458, TPS70402
DUAL-OUTPUT LOW-DROPOUT VOLTAGE REGULATORS
WITH INTEGRATED SVS FOR SPLIT VOLTAGE SYSTEMS

SLVS307B – SEPTEMBER 2000 – REVISED APRIL 2003

TYPICAL CHARACTERISTICS

OUTPUT SPECTRAL NOISE DENSITY
vs
FREQUENCY

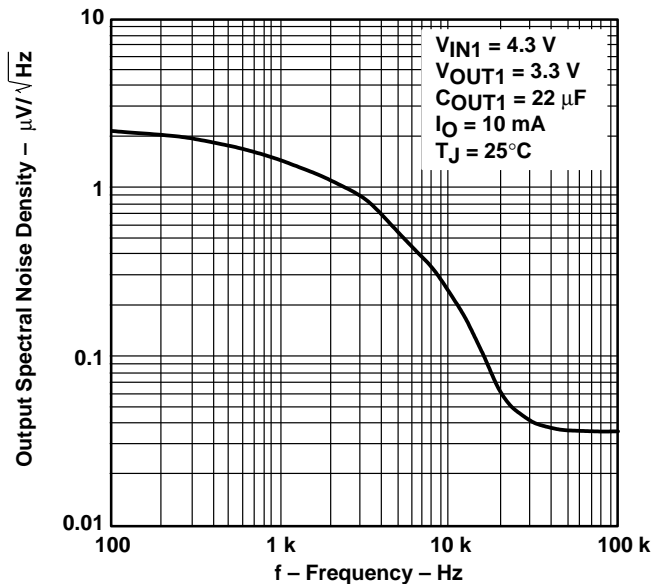

Figure 10

OUTPUT SPECTRAL NOISE DENSITY
vs
FREQUENCY

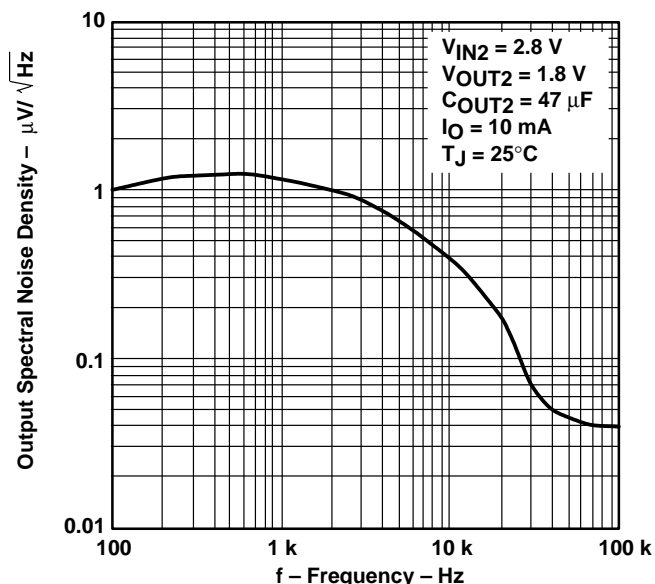

Figure 11

OUTPUT SPECTRAL NOISE DENSITY
vs
FREQUENCY

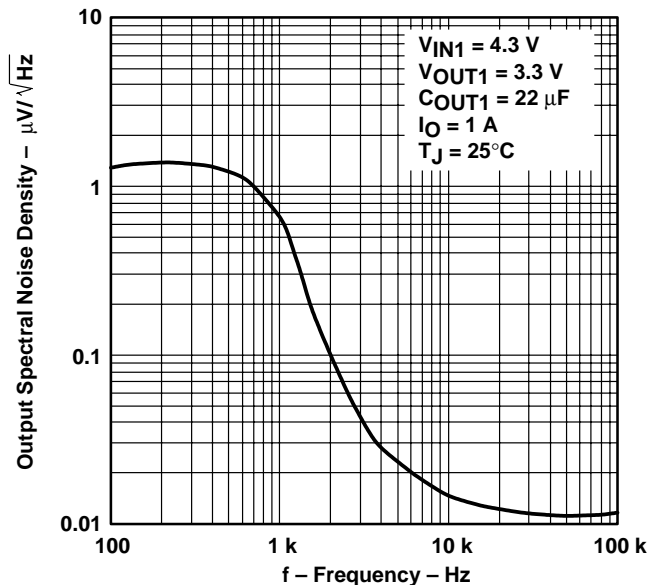

Figure 12

OUTPUT SPECTRAL NOISE DENSITY
vs
FREQUENCY

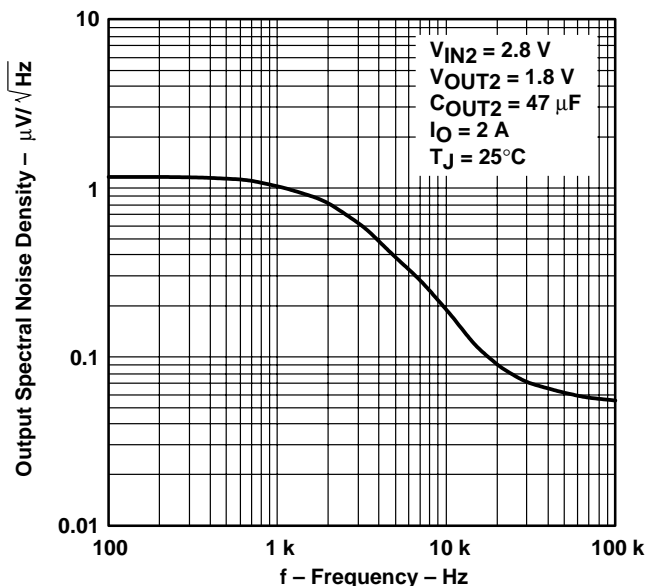

Figure 13



TYPICAL CHARACTERISTICS

OUTPUT IMPEDANCE
 vs
 FREQUENCY

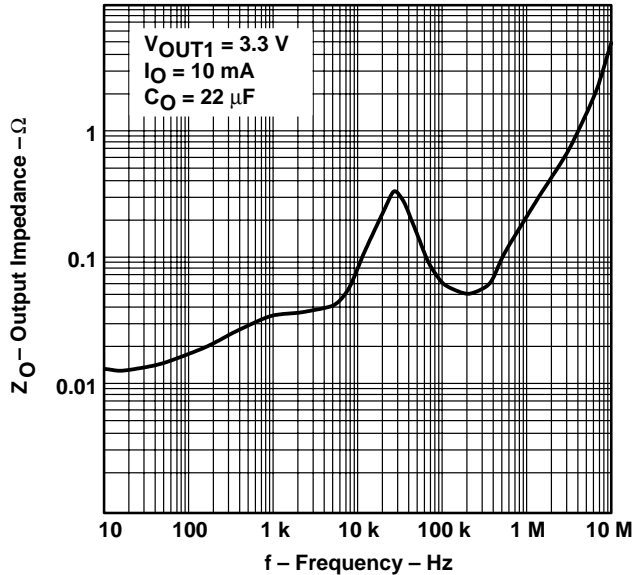

Figure 14

OUTPUT IMPEDANCE
 vs
 FREQUENCY

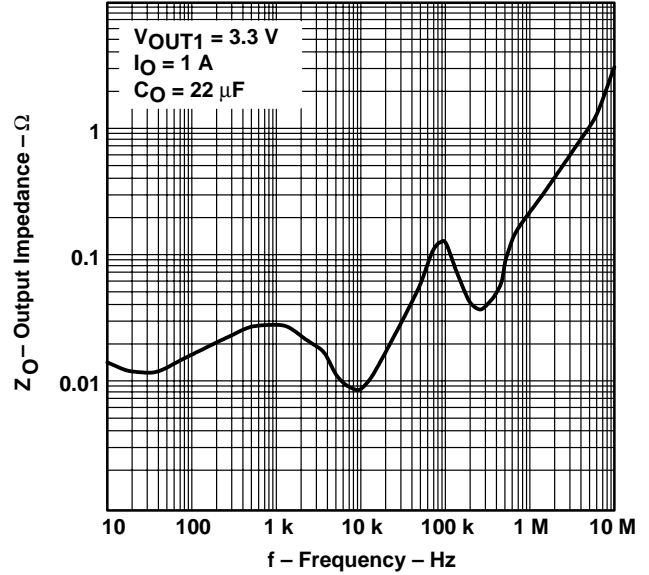

Figure 15

OUTPUT IMPEDANCE
 vs
 FREQUENCY

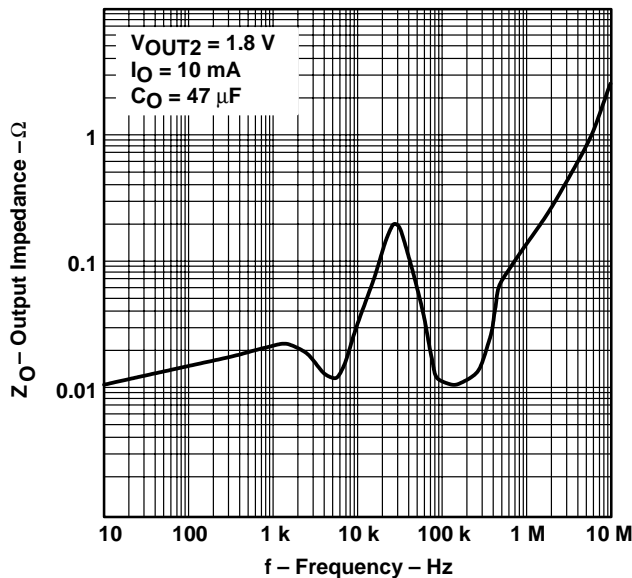

Figure 16

OUTPUT IMPEDANCE
 vs
 FREQUENCY

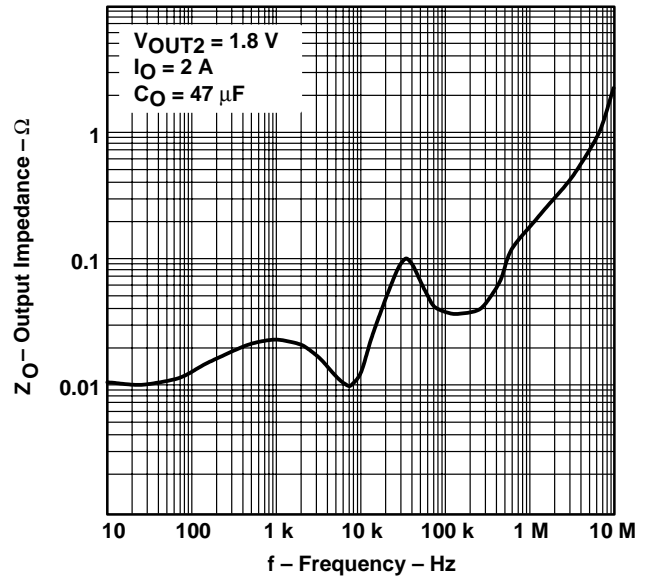

Figure 17

TPS70445, TPS70448, TPS70451, TPS70458, TPS70402
DUAL-OUTPUT LOW-DROPOUT VOLTAGE REGULATORS
WITH INTEGRATED SVS FOR SPLIT VOLTAGE SYSTEMS

SLVS307B – SEPTEMBER 2000 – REVISED APRIL 2003

TYPICAL CHARACTERISTICS

TPS70451
DROPOUT VOLTAGE
vs
TEMPERATURE

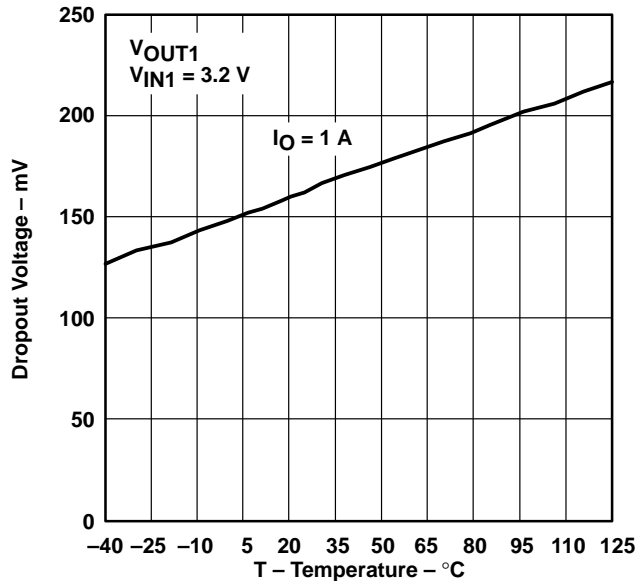

Figure 18

TPS70451
DROPOUT VOLTAGE
vs
TEMPERATURE

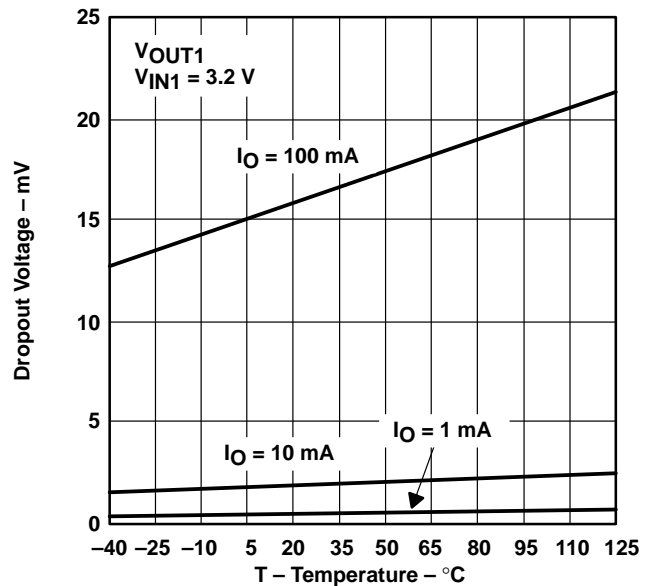

Figure 19

TPS70402
DROPOUT VOLTAGE
vs
INPUT VOLTAGE

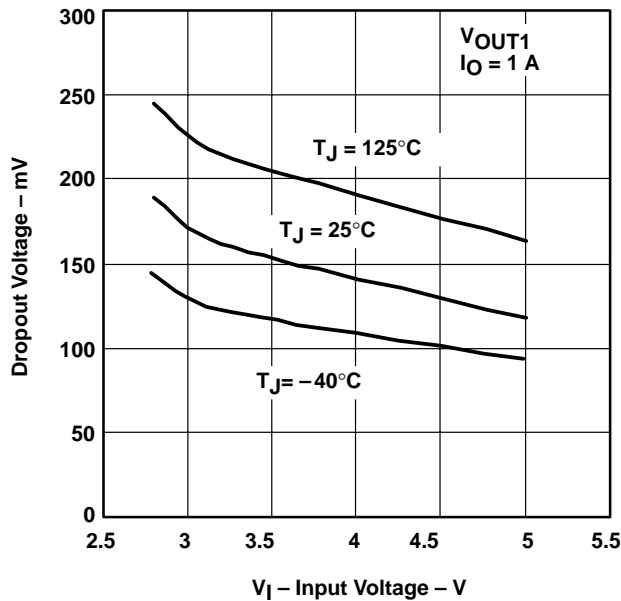

Figure 20

TPS70402
DROPOUT VOLTAGE
vs
INPUT VOLTAGE

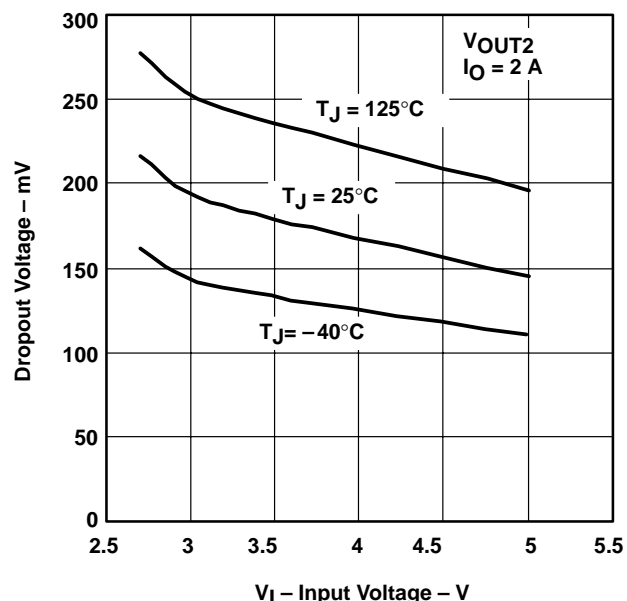

Figure 21



TYPICAL CHARACTERISTICS

LOAD TRANSIENT RESPONSE

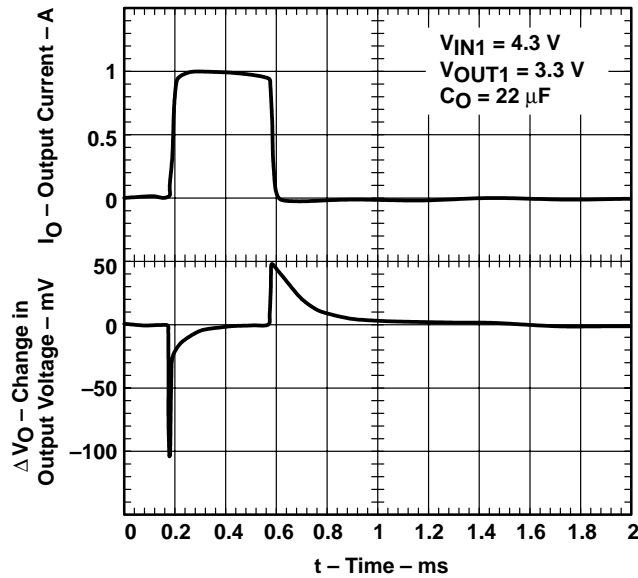

Figure 22

LOAD TRANSIENT RESPONSE

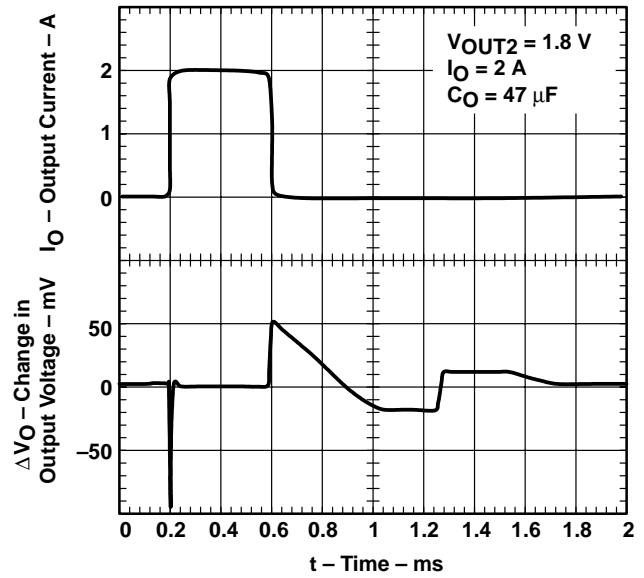

Figure 23

LINE TRANSIENT RESPONSE

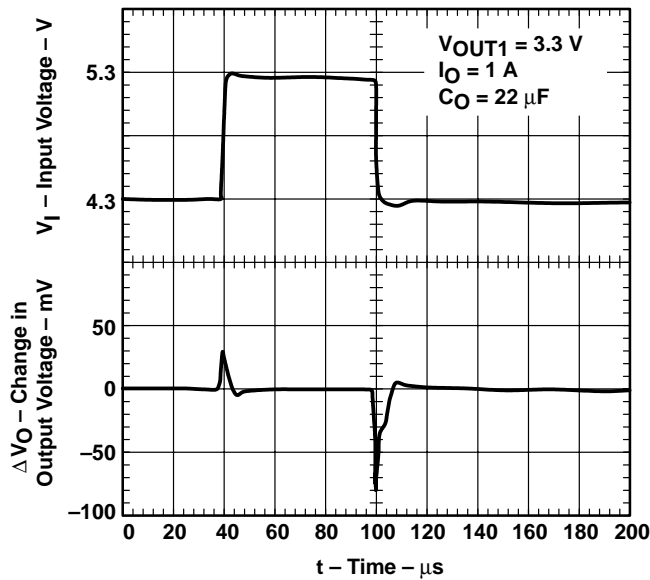

Figure 24

LINE TRANSIENT RESPONSE

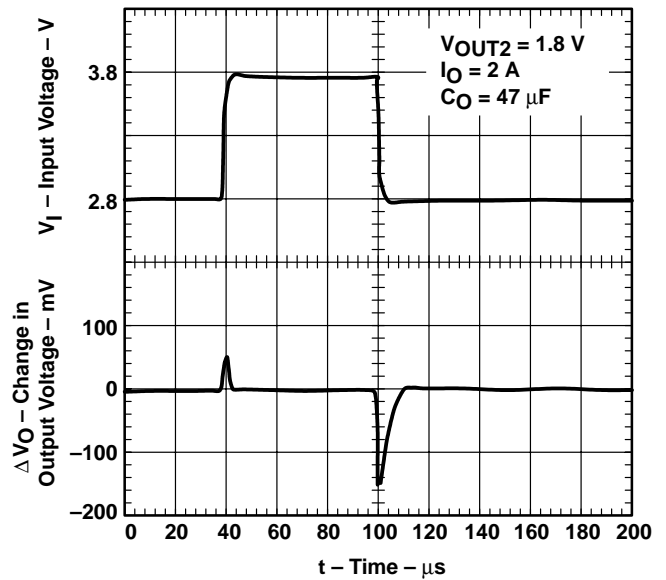

Figure 25

TPS70445, TPS70448, TPS70451, TPS70458, TPS70402
DUAL-OUTPUT LOW-DROPOUT VOLTAGE REGULATORS
WITH INTEGRATED SVS FOR SPLIT VOLTAGE SYSTEMS

SLVS307B – SEPTEMBER 2000 – REVISED APRIL 2003

TYPICAL CHARACTERISTICS

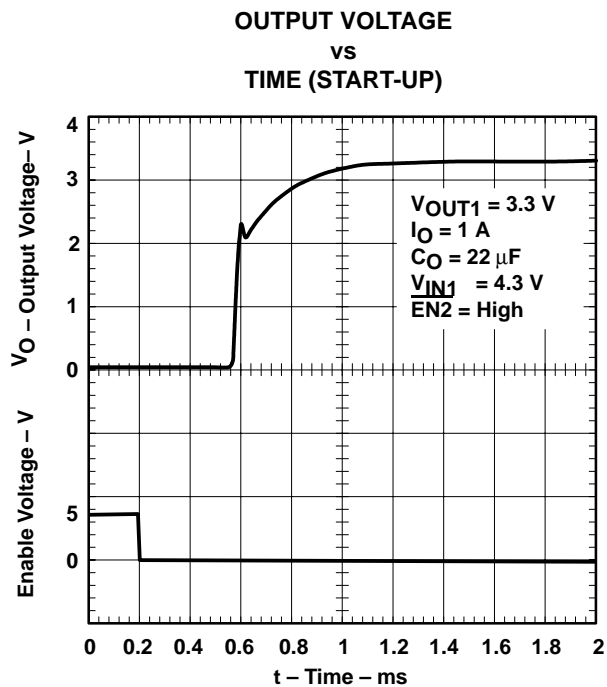

Figure 26

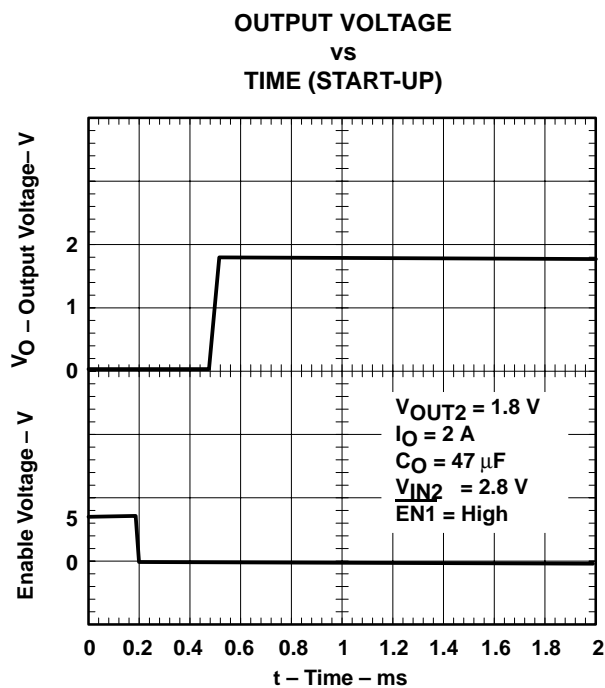

Figure 27

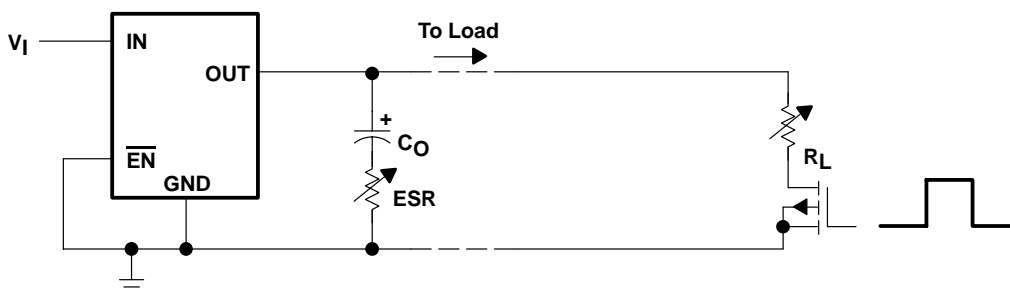

Figure 28. Test Circuit for Typical Regions of Stability

† Equivalent series resistance (ESR) refers to the total series resistance, including the ESR of the capacitor, any series resistance added externally, and PWB trace resistance to C_O .

TYPICAL CHARACTERISTICS

TYPICAL REGION OF STABILITY
 EQUIVALENT SERIES RESISTANCE†
 vs
 OUTPUT CURRENT

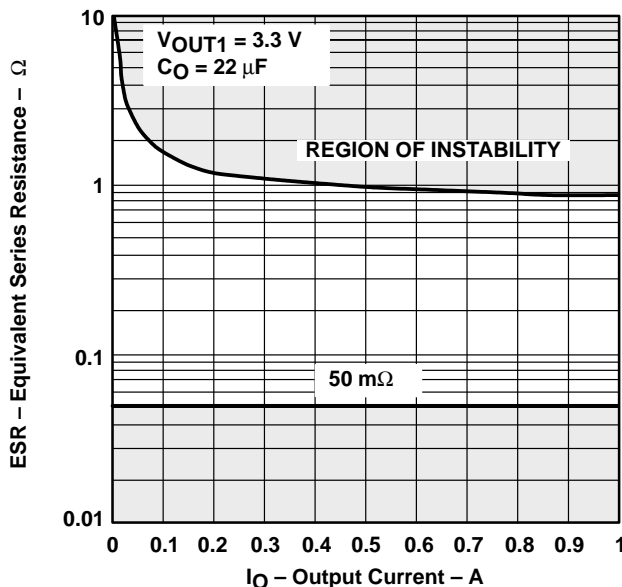

Figure 29

TYPICAL REGION OF STABILITY
 EQUIVALENT SERIES RESISTANCE†
 vs
 OUTPUT CURRENT

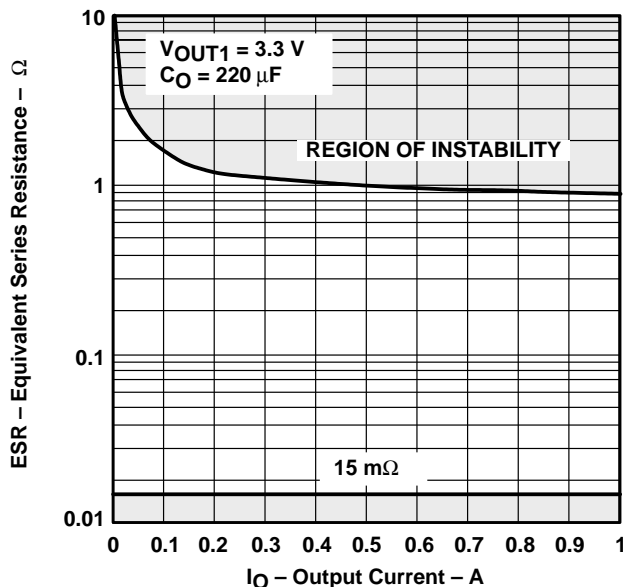

Figure 30

TYPICAL REGION OF STABILITY
 EQUIVALENT SERIES RESISTANCE†
 vs
 OUTPUT CURRENT

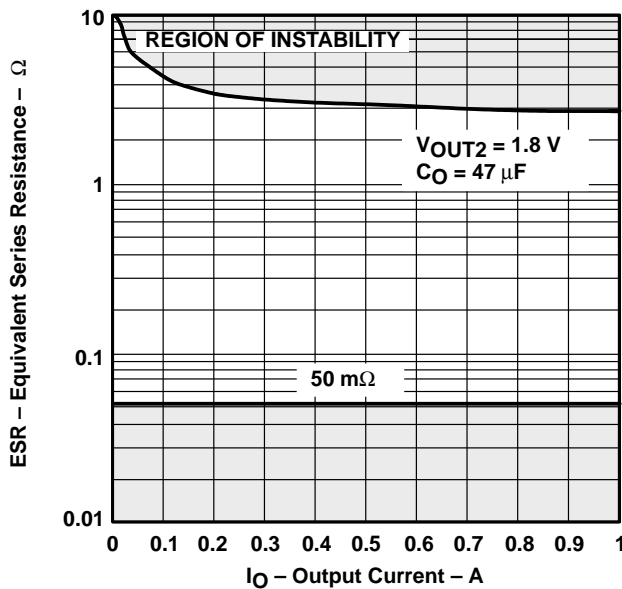

Figure 31

TYPICAL REGION OF STABILITY
 EQUIVALENT SERIES RESISTANCE†
 vs
 OUTPUT CURRENT

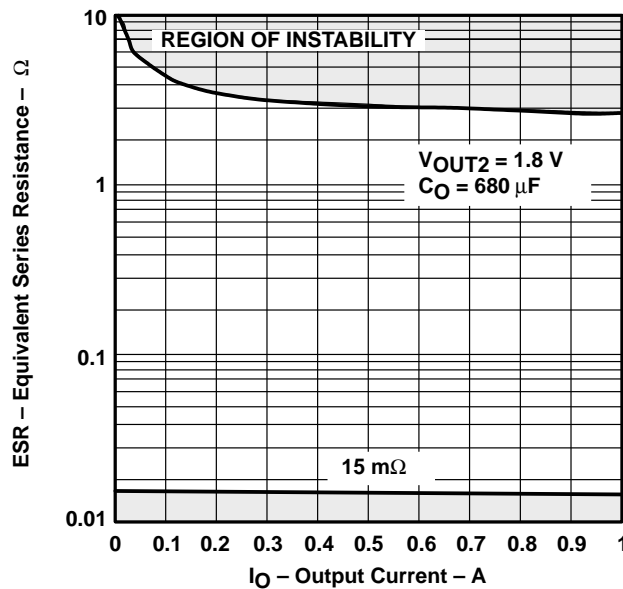

Figure 32

† Equivalent series resistance (ESR) refers to the total series resistance, including the ESR of the capacitor, any series resistance added externally, and PWB trace resistance to C_O .

THERMAL INFORMATION

thermally enhanced TSSOP-24 (PWP – PowerPad™)

The thermally enhanced PWP package is based on the 24-pin TSSOP, but includes a thermal pad [see Figure 33(c)] to provide an effective thermal contact between the IC and the PWB.

Traditionally, surface mount and power have been mutually exclusive terms. A variety of scaled-down TO220-type packages have leads formed as gull wings to make them applicable for surface-mount applications. These packages, however, suffer from several shortcomings: they do not address the very low profile requirements (<2 mm) of many of today's advanced systems, and they do not offer a pin-count high enough to accommodate increasing integration. On the other hand, traditional low-power surface-mount packages require power-dissipation derating that severely limits the usable range of many high-performance analog circuits.

The PWP package (thermally enhanced TSSOP) combines fine-pitch surface-mount technology with thermal performance comparable to much larger power packages.

The PWP package is designed to optimize the heat transfer to the PWB. Because of the very small size and limited mass of a TSSOP package, thermal enhancement is achieved by improving the thermal conduction paths that remove heat from the component. The thermal pad is formed using a lead-frame design (patent pending) and manufacturing technique to provide the user with direct connection to the heat-generating IC. When this pad is soldered or otherwise coupled to an external heat dissipator, high power dissipation in the ultrathin, fine-pitch, surface-mount package can be reliably achieved.

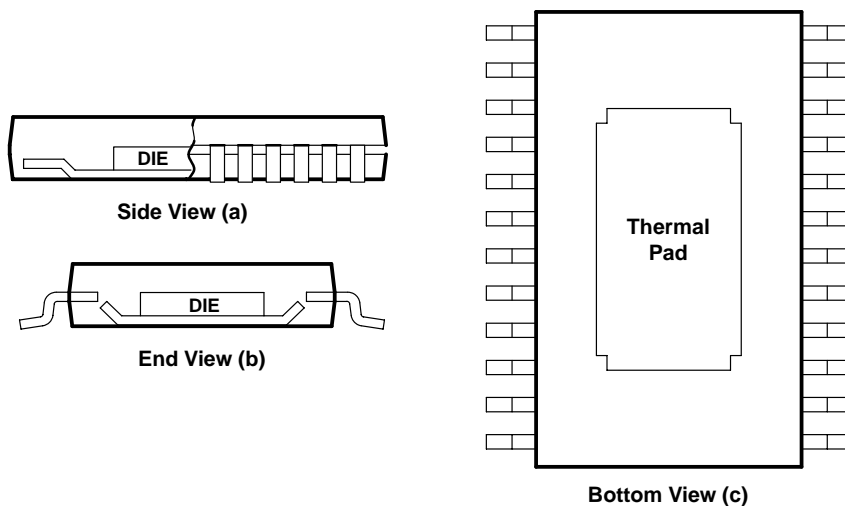

Figure 33. Views of Thermally Enhanced PWP Package

Because the conduction path has been enhanced, power-dissipation capability is determined by the thermal considerations in the PWB design. For example, simply adding a localized copper plane (heat-sink surface), which is coupled to the thermal pad, enables the PWP package to dissipate 2.5 W in free air (reference Figure 35(a), 8 cm² of copper heat sink and natural convection). Increasing the heat-sink size increases the power dissipation range for the component. The power dissipation limit can be further improved by adding airflow to a PWB/IC assembly (see Figures 34 and 35). The line drawn at 0.3 cm² in Figures 34 and 35 indicates performance at the minimum recommended heat-sink size, illustrated in Figure 36.

THERMAL INFORMATION

thermally enhanced TSSOP-24 (PWP – PowerPad™) (continued)

The thermal pad is directly connected to the substrate of the IC, which for the TPS704xx series is a secondary electrical connection to device ground. The heat-sink surface that is added to the PWP can be a ground plane or left electrically isolated. In TO220-type surface-mount packages, the thermal connection is also the primary electrical connection for a given terminal which is not always ground. The PWP package provides up to 24 independent leads that can be used as inputs and outputs (Note: leads 1, 12, 13, and 24 are internally connected to the thermal pad and the IC substrate).

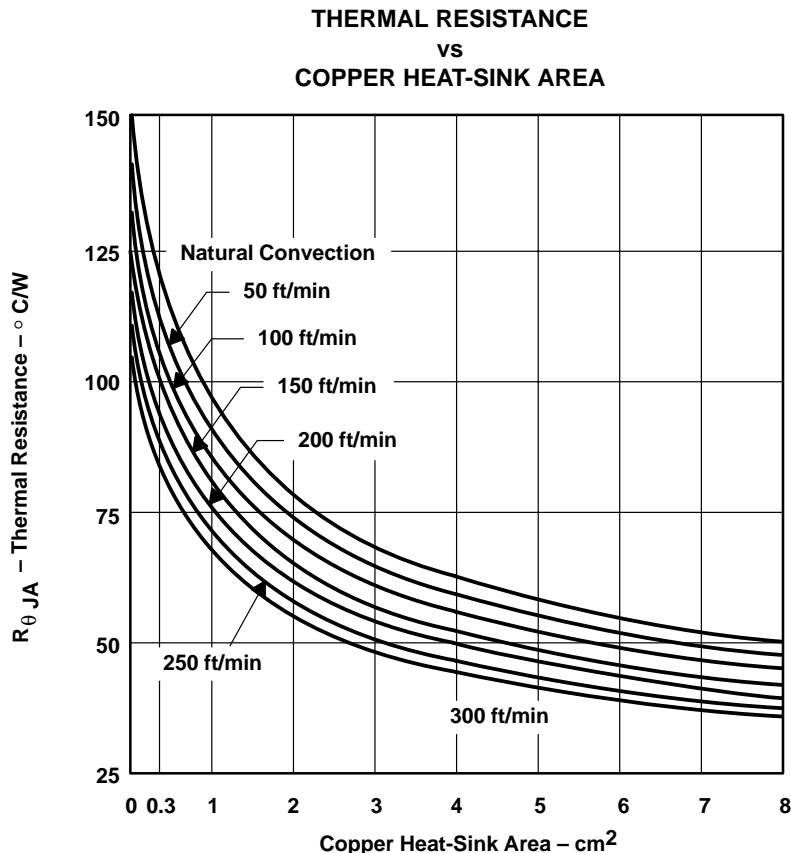

Figure 34

TPS70445, TPS70448, TPS70451, TPS70458, TPS70402
DUAL-OUTPUT LOW-DROPOUT VOLTAGE REGULATORS
WITH INTEGRATED SVS FOR SPLIT VOLTAGE SYSTEMS

SLVS307B – SEPTEMBER 2000 – REVISED APRIL 2003

THERMAL INFORMATION

thermally enhanced TSSOP-24 (PWP – PowerPad™) (continued)

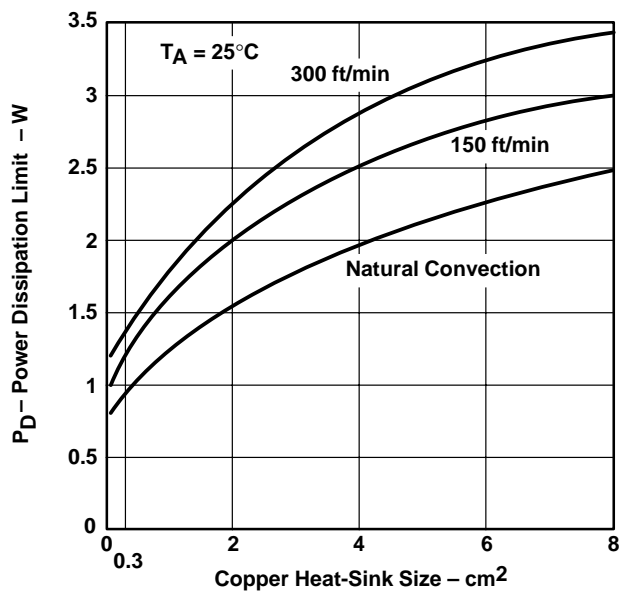

(a)

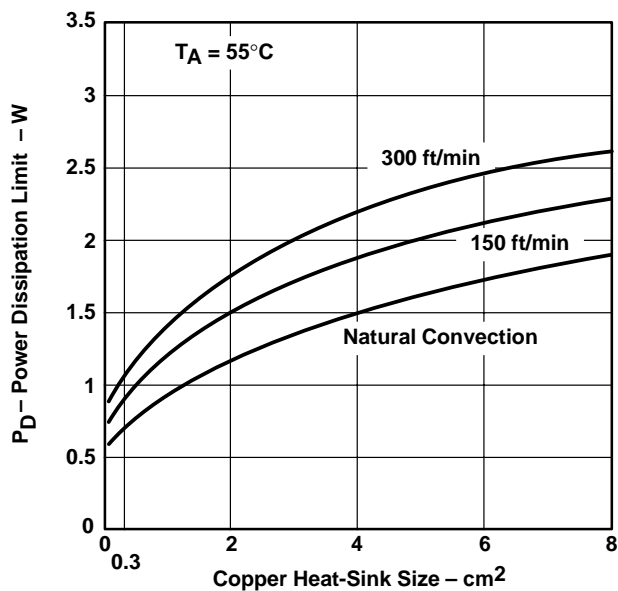

(b)

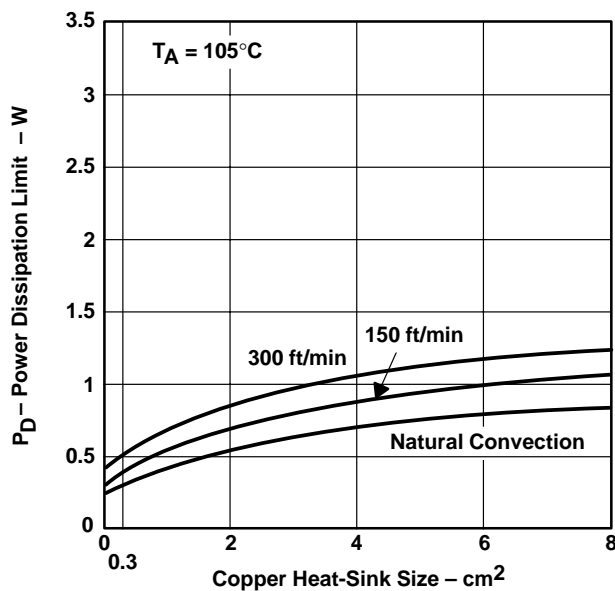

(c)

Figure 35. Power Ratings of the PWP Package at Ambient Temperatures of 25°C, 55°C, and 105°C

THERMAL INFORMATION

thermally enhanced TSSOP-24 (PWP – PowerPad™) (continued)

Figure 36 is an example of a thermally enhanced PWB layout for use with the new PWP package. This board configuration was used in the thermal experiments that generated the power ratings shown in Figure 34 and Figure 35. As discussed earlier, copper has been added on the PWB to conduct heat away from the device. $R_{\theta JA}$ for this assembly is illustrated in Figure 34 as a function of heat-sink area. A family of curves is included to illustrate the effect of airflow introduced into the system.

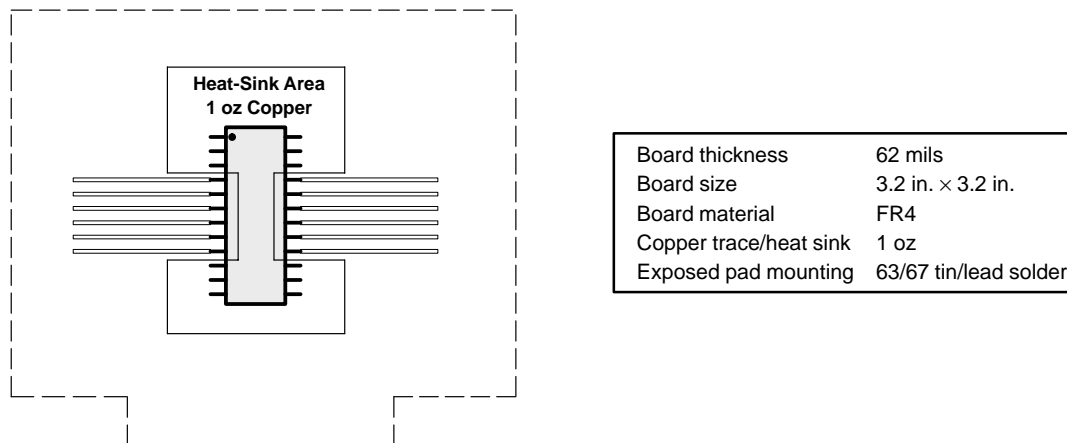

Figure 36. PWB Layout (Including Copper Heatsink Area) for Thermally Enhanced PWP Package

From Figure 34, $R_{\theta JA}$ for a PWB assembly can be determined and used to calculate the maximum power-dissipation limit for the component/PWB assembly, with the equation:

$$P_{D(max)} = \frac{T_{Jmax} - T_A}{R_{\theta JA(system)}} \quad (4)$$

Where:

T_{Jmax} is the maximum specified junction temperature (150°C absolute maximum limit, 125°C recommended operating limit) and T_A is the ambient temperature.

$P_{D(max)}$ should then be applied to the internal power dissipated by the TPS704xx regulator. The equation for calculating total internal power dissipation of the TPS704xx is:

$$P_{D(total)} = (V_{IN1} - V_{OUT1}) \times I_{OUT1} + V_{IN1} \times \frac{I_Q}{2} + (V_{IN2} - V_{OUT2}) \times I_{OUT2} + V_{IN2} \times \frac{I_Q}{2} \quad (5)$$

Since the quiescent current of the TPS704xx is very low, the second term is negligible, further simplifying the equation to:

$$P_{D(total)} = (V_{IN1} - V_{OUT1}) \times I_{OUT1} + (V_{IN2} - V_{OUT2}) \times I_{OUT2} \quad (6)$$

For the case where $T_A = 55^\circ\text{C}$, airflow = 200 ft/min, copper heat-sink area = 4 cm², the maximum power-dissipation limit can be calculated. First, from Figure 34, we find the system $R_{\theta JA}$ is 50°C/W; therefore, the maximum power-dissipation limit is:

$$P_{D(max)} = \frac{T_{Jmax} - T_A}{R_{\theta JA(system)}} = \frac{125^\circ\text{C} - 55^\circ\text{C}}{50^\circ\text{C/W}} = 1.4 \text{ W} \quad (7)$$

TPS70445, TPS70448, TPS70451, TPS70458, TPS70402 DUAL-OUTPUT LOW-DROPOUT VOLTAGE REGULATORS WITH INTEGRATED SVS FOR SPLIT VOLTAGE SYSTEMS

SLVS307B – SEPTEMBER 2000 – REVISED APRIL 2003

THERMAL INFORMATION

thermally enhanced TSSOP-24 (PWP – PowerPad™) (continued)

If the system implements a TPS70451 regulator, where $V_{IN1} = 4.3\text{ V}$, $I_{OUT1} = 0.5\text{ A}$, $V_{IN2} = 2.8\text{ V}$, and $I_{OUT2} = 0.75\text{ A}$, the internal power dissipation is:

$$P_{D(\text{total})} = (V_{IN1} - V_{OUT1}) \times I_{OUT1} + (V_{IN2} - V_{OUT2}) \times I_{OUT2} \quad (8)$$
$$= (4.3 - 3.3) \times 0.5 + (2.8 - 1.8) \times 0.75 = 1.25\text{ W}$$

Comparing $P_{D(\text{total})}$ with $P_{D(\text{max})}$ reveals that the power dissipation in this example does not exceed the calculated limit. When it does, one of two corrective actions should be made: raising the power-dissipation limit by increasing the airflow or the heat-sink area, or lowering the internal power dissipation of the regulator by reducing the input voltage or the load current. In either case, the above calculations should be repeated with the new system parameters. This parameter is measured with the recommended copper heat sink pattern on a 4-layer PCB, 2 oz. copper traces on 4-in \times 4-in ground layer. Simultaneous and continuous operation of both regulator outputs at full load may exceed the power dissipation rating of the PWP package.

mounting information

The primary requirement is to complete the thermal contact between the thermal pad and the PWB metal. The thermal pad is a solderable surface and is fully intended to be soldered at the time the component is mounted. Although voiding in the thermal-pad solder-connection is not desirable, up to 50% voiding is acceptable. The data included in Figures 34 and 35 is for soldered connections with voiding between 20% and 50%. The thermal analysis shows no significant difference resulting from the variation in voiding percentage.

Figure 37 shows the solder-mask land pattern for the PWP package. The minimum recommended heat-sink area is also illustrated. This is simply a copper plane under the body extent of the package, including metal routed under terminals 1, 12, 13, and 24.

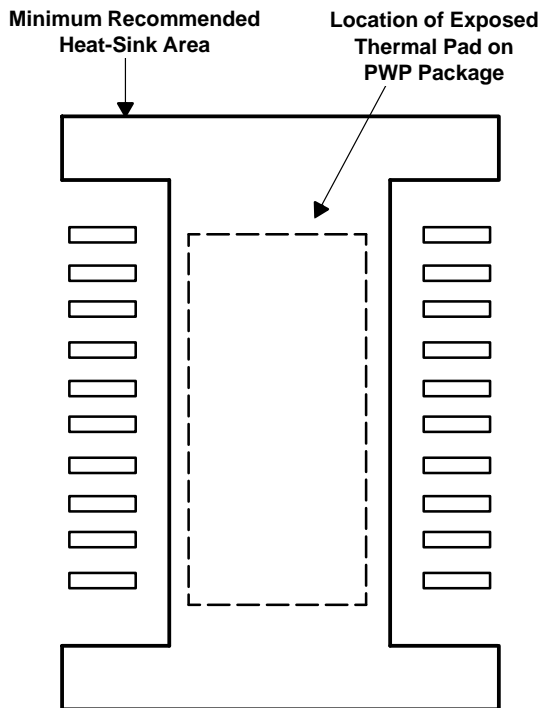

Figure 37. PWP Package Land Pattern

APPLICATION INFORMATION

timing diagrams

The following figures provide a timing diagram of how this device functions in different configurations.

application conditions not shown in block diagram:

V_{IN1} and V_{IN2} are tied to the same fixed input voltage greater than the V_{UVLO} . PG2 is tied to MR.

explanation of timing diagrams:

$\overline{EN1}$ and $\overline{EN2}$ are initially high; therefore, both regulators are off, and PG1 and PG2 (tied to MR) are at logic low. Since MR is at logic low, RESET is also at logic low. When EN1 is taken to logic low, V_{OUT1} turns on. Later, when EN2 is taken to logic low, V_{OUT2} turns on. When V_{OUT1} reaches 95% of its regulated output voltage, PG1 goes to logic high. When V_{OUT2} reaches 95% of its regulated output voltage, PG2 (tied to MR) goes to logic high. When V_{IN1} is greater than V_{UVLO} and MR (tied to PG2) is at logic high, RESET is pulled to logic high after a 120 ms delay. When EN1 and EN2 are returned to logic high, both devices power down and both PG1, PG2 (tied to MR2), and RESET return to logic low.

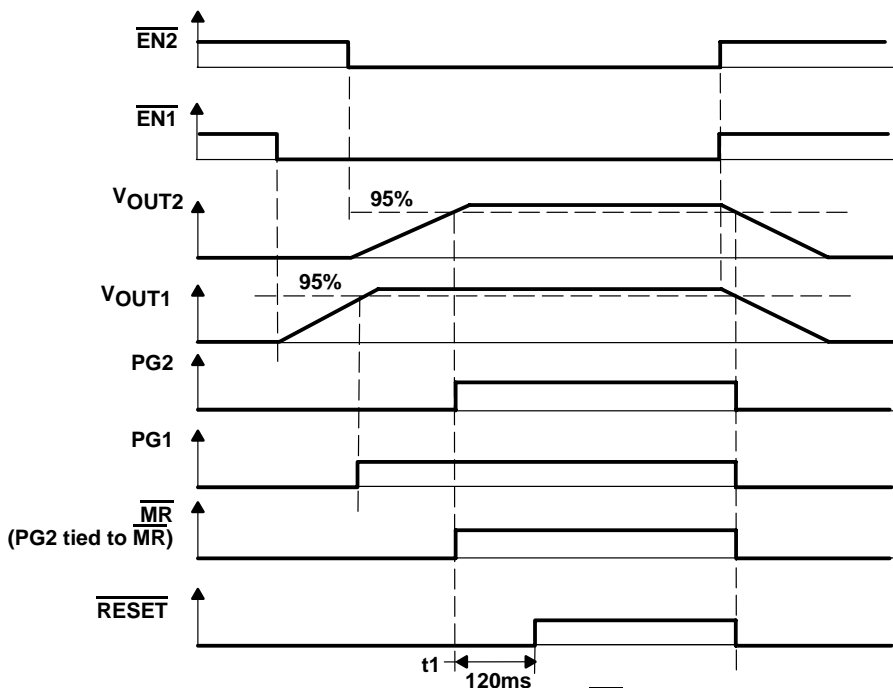
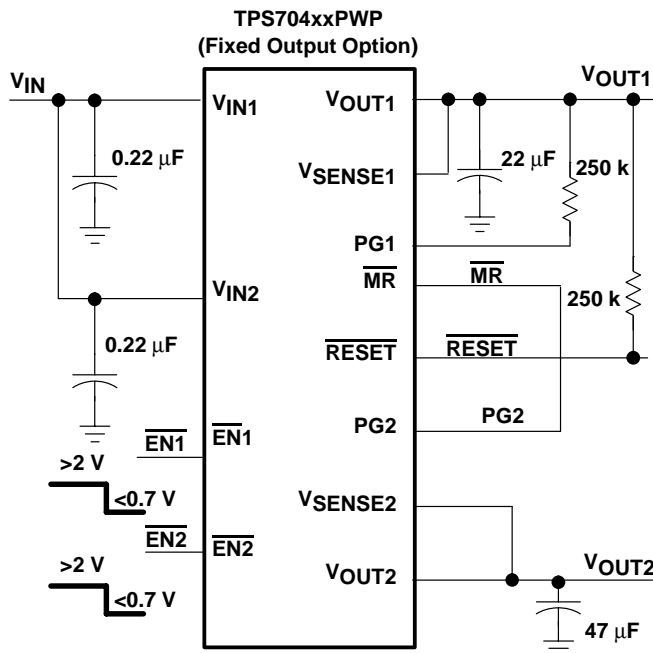

NOTE A: t_1 – Time at which V_{IN} is greater than V_{UVLO} and MR is logic high.
 NOTE B: The timing diagrams are not drawn to scale.

Figure 38. Timing When V_{OUT1} Is Enabled Before V_{OUT2}

TPS70445, TPS70448, TPS70451, TPS70458, TPS70402 DUAL-OUTPUT LOW-DROPOUT VOLTAGE REGULATORS WITH INTEGRATED SVS FOR SPLIT VOLTAGE SYSTEMS

SLVS307B – SEPTEMBER 2000 – REVISED APRIL 2003

APPLICATION INFORMATION

application conditions not shown in block diagram:

V_{IN1} and V_{IN2} are tied to the same fixed input voltage greater than V_{UVLO} . \overline{MR} is initially logic high but is eventually toggled.

explanation of timing diagrams:

$\overline{EN1}$ and $\overline{EN2}$ are initially high; therefore, both regulators are off, and PG1 and PG2 are at logic low. Since V_{IN1} is greater than V_{UVLO} and \overline{MR} is at logic high, \overline{RESET} is also at logic high. When $\overline{EN2}$ is taken to logic low, V_{OUT2} turns on. Later, when $\overline{EN1}$ is taken to logic low, V_{OUT1} turns on. When V_{OUT2} reaches 95% of its regulated output voltage, PG2 goes to logic high. When V_{OUT1} reaches 95% of its regulated output voltage, PG1 goes to logic high. When \overline{MR} is taken to logic low, \overline{RESET} is taken low. When \overline{MR} returns to logic high, \overline{RESET} returns to logic high after a 120 ms delay.

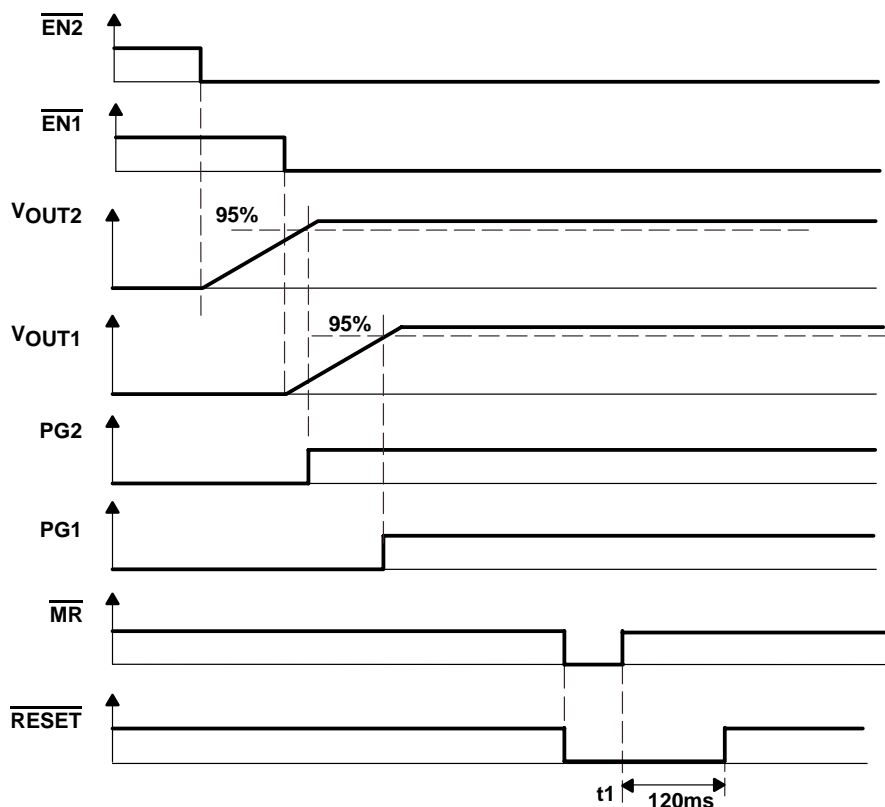
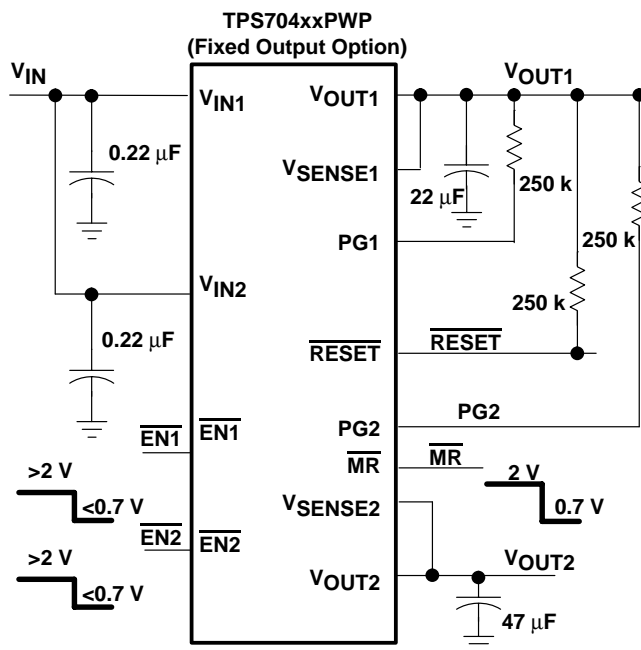

- NOTES: A. t_1 – Time at which V_{IN} is greater than V_{UVLO} and \overline{MR} is logic high.
B. The timing diagram is not drawn to scale.

Figure 39. Timing When \overline{MR} Is Toggled

TPS70445, TPS70448, TPS70451, TPS70458, TPS70402 DUAL-OUTPUT LOW-DROPOUT VOLTAGE REGULATORS WITH INTEGRATED SVS FOR SPLIT VOLTAGE SYSTEMS

SLVS307B – SEPTEMBER 2000 – REVISED APRIL 2003

APPLICATION INFORMATION

application conditions not shown in block diagram:

V_{IN1} and V_{IN2} are tied to same fixed input voltage greater than V_{UVLO} . PG1 is tied to \overline{MR} .

explanation of timing diagrams:

$\overline{EN1}$ and $\overline{EN2}$ are initially high; therefore, both regulators are off, and PG1 (tied to \overline{MR}) and PG2 are at logic low. Since \overline{MR} is at logic low, \overline{RESET} is also at logic low. When $\overline{EN2}$ is taken to logic low, V_{OUT2} turns on. Later, when $\overline{EN1}$ is taken to logic low, V_{OUT1} turns on. When V_{OUT2} reaches 95% of its regulated output voltage, PG2 goes to logic high. When V_{OUT1} reaches 95% of its regulated output voltage, PG1 goes to logic high. When V_{IN1} is greater than V_{UVLO} and \overline{MR} (tied to PG2) is at logic high, \overline{RESET} is pulled to logic high after a 120 ms delay. When a fault on V_{OUT1} causes it to fall below 95% of its regulated output voltage, PG1 (tied to \overline{MR}) goes to logic low. Since \overline{MR} is logic low, \overline{RESET} goes to logic low. V_{OUT2} is unaffected.

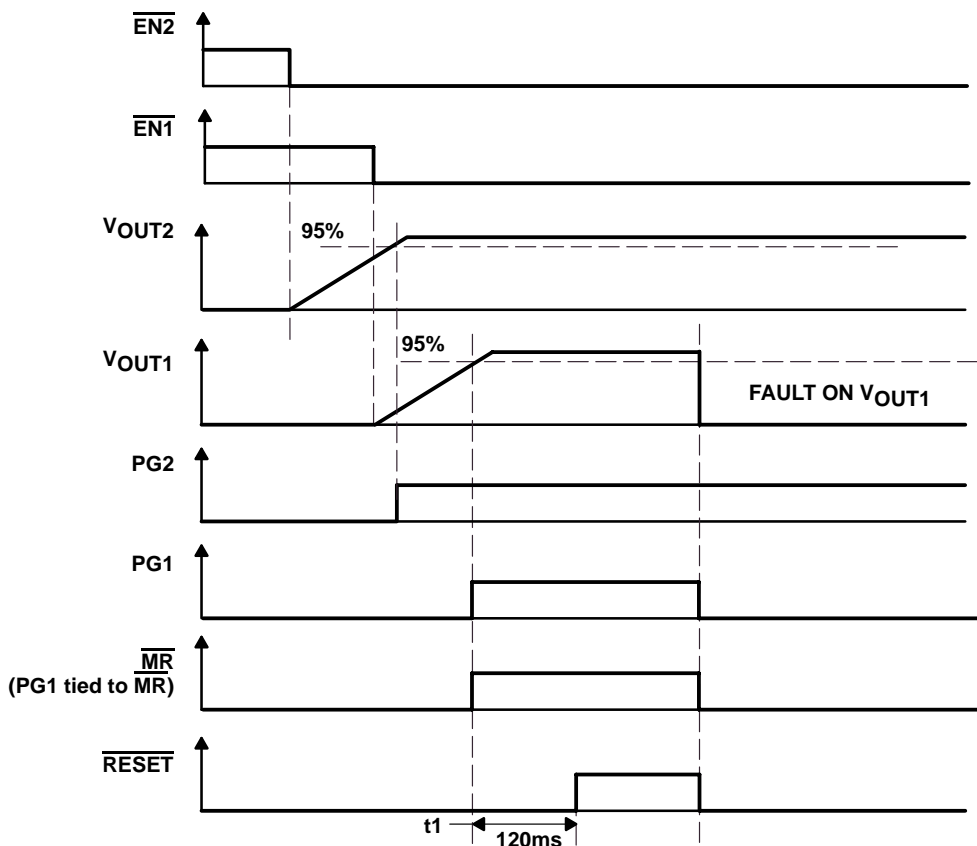
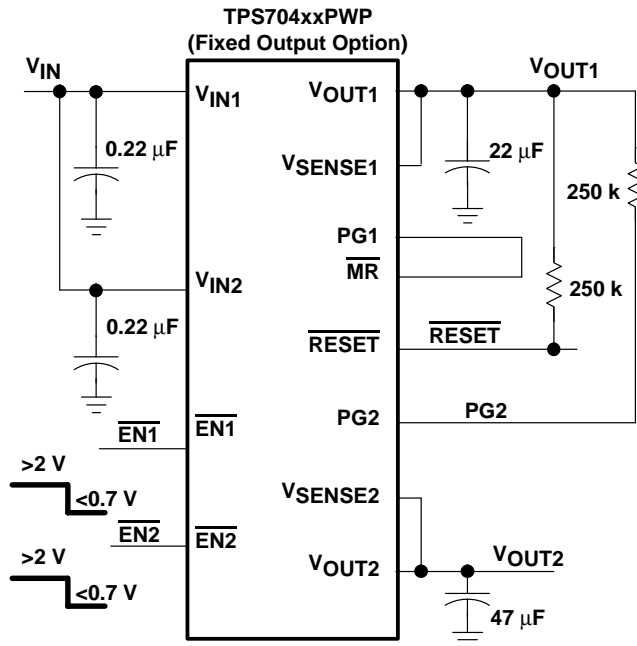

NOTES: A. t_1 – Time at which V_{IN} is greater than V_{UVLO} and \overline{MR} is logic high.
B. The timing diagram is not drawn to scale.

Figure 40. Timing When There Is a Fault on V_{OUT1}

TPS70445, TPS70448, TPS70451, TPS70458, TPS70402 DUAL-OUTPUT LOW-DROPOUT VOLTAGE REGULATORS WITH INTEGRATED SVS FOR SPLIT VOLTAGE SYSTEMS

SLVS307B – SEPTEMBER 2000 – REVISED APRIL 2003

APPLICATION INFORMATION

input capacitor

For a typical application, a ceramic input bypass capacitor (0.22 μF – 1 μF) is recommended to ensure device stability. This capacitor should be as close to the input pins as possible. Due to the impedance of the input supply, large transient currents cause the input voltage to droop. If this droop causes the input voltage to drop below the UVLO threshold, the device turns off. Therefore, it is recommended to place a larger capacitor in parallel with the ceramic bypass capacitor at the regulator's input. The size of this capacitor is dependent upon the output current, response time of the main power supply, and the main power supply's distance to the regulator. At a minimum, the capacitor should be sized to ensure that the input voltage does not drop below the minimum UVLO threshold voltage during normal operating conditions.

output capacitor

As with most LDO regulators, the TPS704xx requires an output capacitor connected between each OUT and GND to stabilize the internal control loop. The minimum recommended capacitance value for $V_{\text{OUT}1}$ is 22 μF and the ESR (equivalent series resistance) must be between 50 m Ω and 800 m Ω . The minimum recommended capacitance value for $V_{\text{OUT}2}$ is 47 μF and the ESR must be between 50 m Ω and 2 Ω . Solid tantalum electrolytic, aluminum electrolytic, and multilayer ceramic capacitors are all suitable, provided they meet the requirements described above. Larger capacitors provide a wider range of stability and better load transient response. Below is a partial listing of surface-mount capacitors usable with the TPS704xx for fast transient response application.

This information, along with the ESR graphs, is included to assist in selection of suitable capacitance for the user's application. When necessary to achieve low height requirements along with high output current and/or high load capacitance, several higher ESR capacitors can be used in parallel to meet the guidelines above.

| VALUE | MFR. | PART NO. |
|-------------------|-------|----------------|
| 680 μF | Kemet | T510X6871004AS |
| 470 μF | Sanyo | 4TPB470M |
| 150 μF | Sanyo | 4TPC150M |
| 220 μF | Sanyo | 2R5TPC220M |
| 100 μF | Sanyo | 6TPC100M |
| 68 μF | Sanyo | 10TPC68M |
| 68 μF | Kemet | T495D6861006AS |
| 47 μF | Kemet | T495D4761010AS |
| 33 μF | Kemet | T495C3361016AS |
| 22 μF | Kemet | T495C2261010AS |



APPLICATION INFORMATION

programming the TPS70402 adjustable LDO regulator

The output voltage of the TPS70402 adjustable regulators is programmed using an external resistor divider as shown in Figure 41.

Resistors R1 and R2 should be chosen for approximately 50-μA divider current. Lower value resistors can be used, but offer no inherent advantage and waste more power. Higher values should be avoided as leakage currents at the sense terminal increase the output voltage error. The recommended design procedure is to choose R2 = 30.1 kΩ to set the divider current at approximately 50 μA and then calculate R1 using:

$$R1 = \left(\frac{V_O}{V_{ref}} - 1 \right) \times R2 \tag{1}$$

where

V_{ref} = 1.224 V typ (the internal reference voltage)

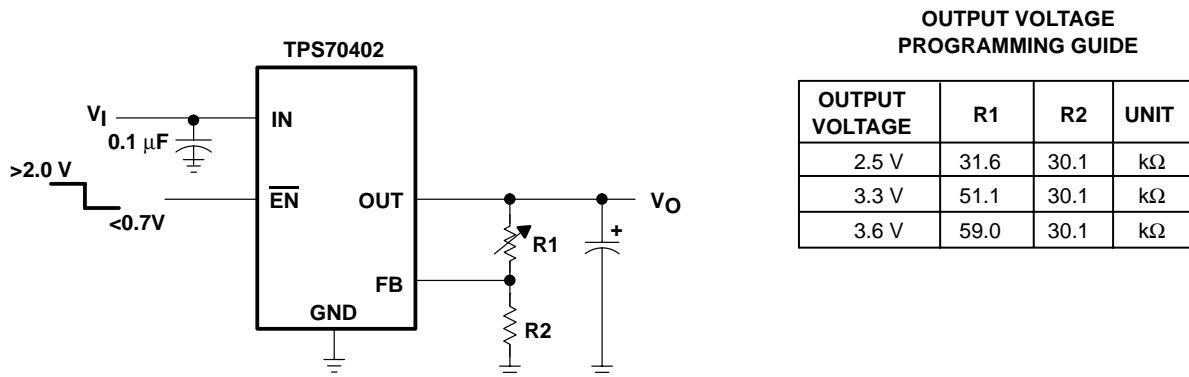

Figure 41. TPS70402 Adjustable LDO Regulator Programming

regulator protection

Both TPS704xx PMOS-pass transistors have built-in back diodes that conduct reverse currents when the input voltage drops below the output voltage (e.g., during power down). Current is conducted from the output to the input and is not internally limited. When extended reverse voltage is anticipated, external limiting may be appropriate.

The TPS704xx also features internal current limiting and thermal protection. During normal operation, the TPS704xx regulator 1 limits output current to approximately 1.75 A (typ) and regulator 2 limits output current to approximately 3.8 A (typ). When current limiting engages, the output voltage scales back linearly until the overcurrent condition ends. While current limiting is designed to prevent gross device failure, care should be taken not to exceed the power dissipation ratings of the package. If the temperature of the device exceeds 150°C(typ), thermal-protection circuitry shuts it down. Once the device has cooled below 130°C(typ), regulator operation resumes.

**TPS70445, TPS70448, TPS70451, TPS70458, TPS70402
DUAL-OUTPUT LOW-DROPOUT VOLTAGE REGULATORS
WITH INTEGRATED SVS FOR SPLIT VOLTAGE SYSTEMS**

SLVS307B – SEPTEMBER 2000 – REVISED APRIL 2003

MECHANICAL DATA

PWP (R-PDSO-G)**

PowerPAD™ PLASTIC SMALL-OUTLINE PACKAGE

20-PIN SHOWN

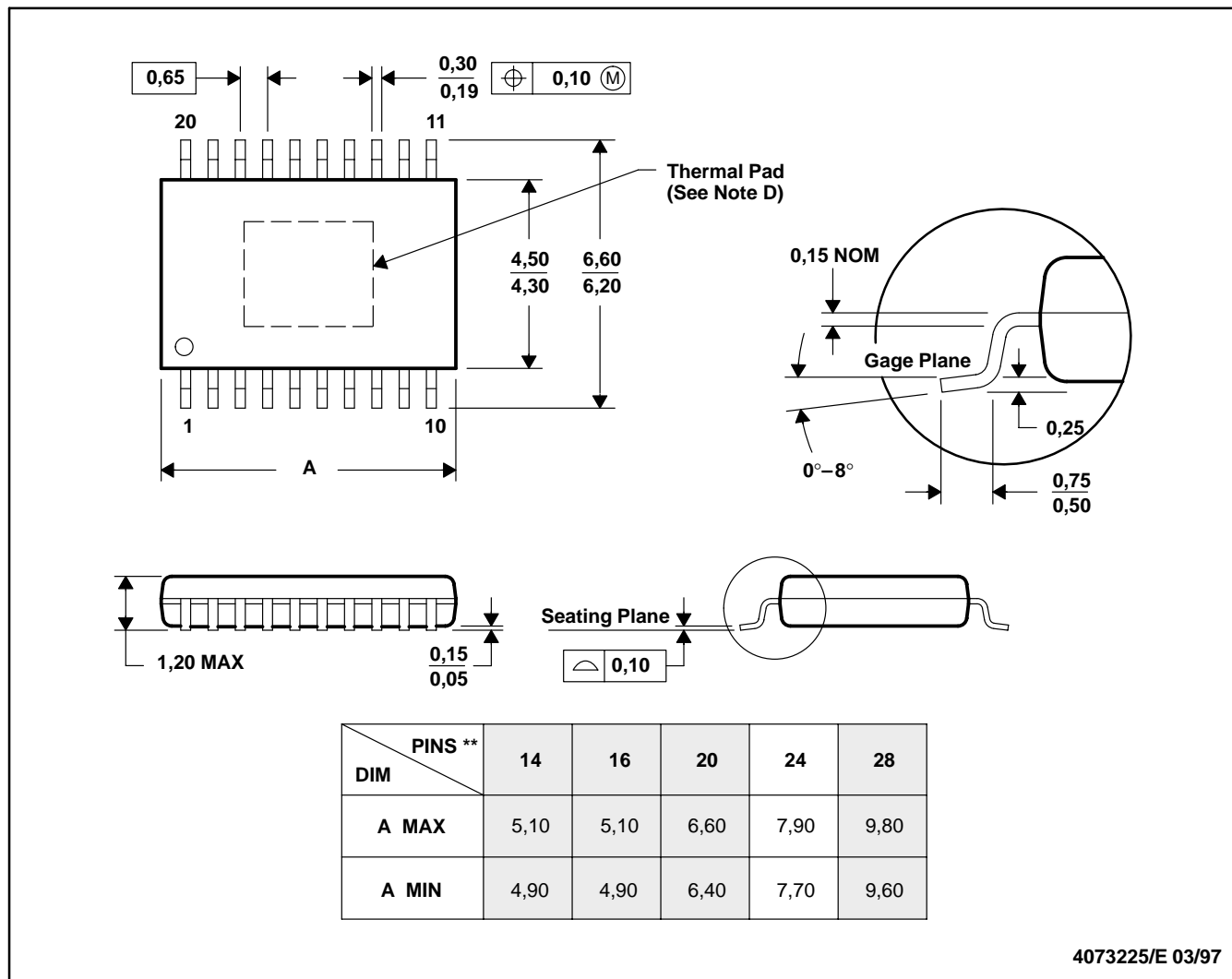

- NOTES: A. All linear dimensions are in millimeters.
 B. This drawing is subject to change without notice.
 C. Body dimensions do not include mold flash or protrusions.
 D. The package thermal performance may be enhanced by bonding the thermal pad to an external thermal plane. This pad is electrically and thermally connected to the backside of the die and possibly selected leads.
 E. Falls within JEDEC MO-153

PowerPAD is a trademark of Texas Instruments.



POST OFFICE BOX 655303 • DALLAS, TEXAS 75265

PWP (R-PDSO-G24)

PowerPAD™ PLASTIC SMALL-OUTLINE

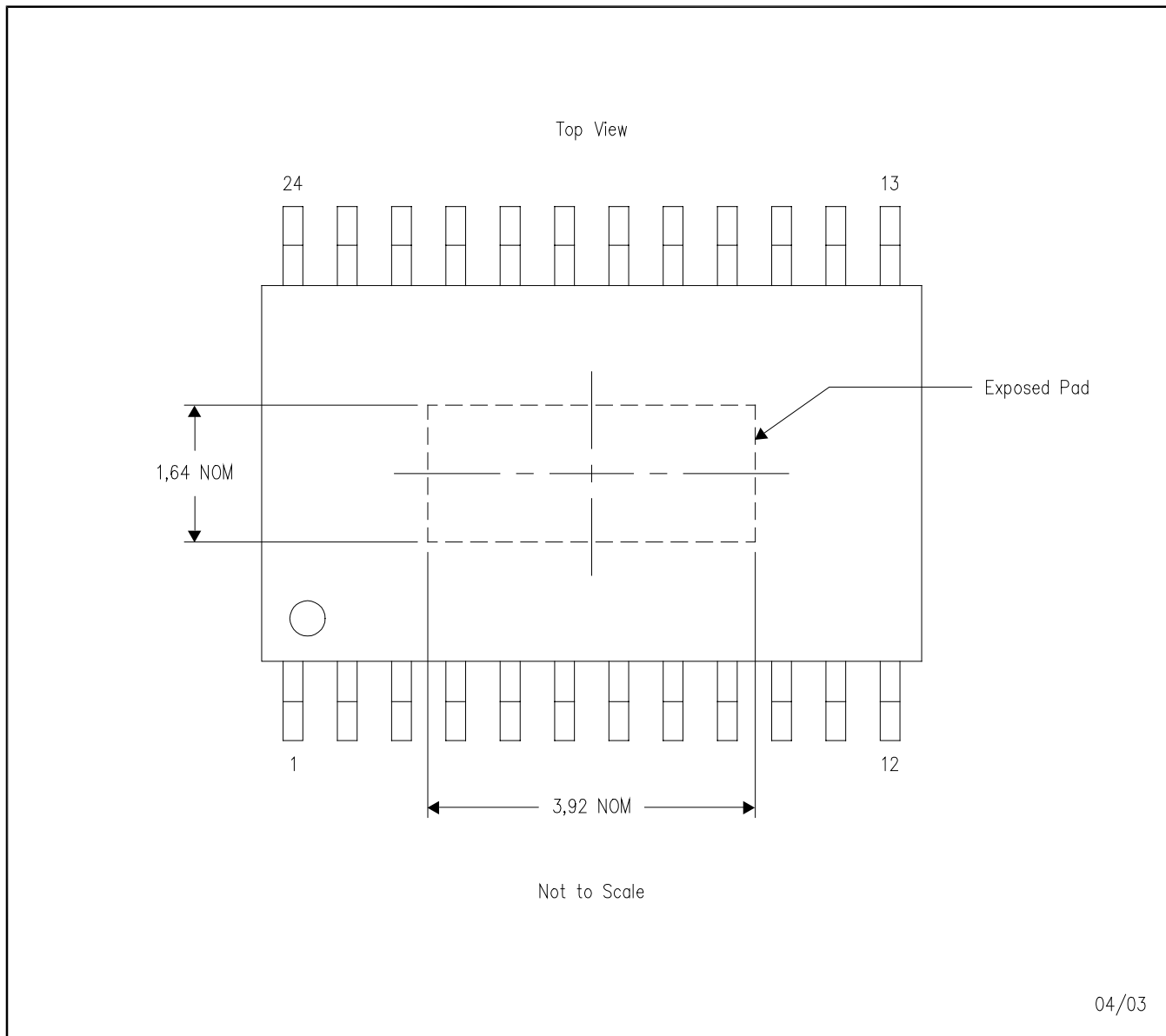

- NOTES:
- A. All linear dimensions are in millimeters.
 - B. This drawing is subject to change without notice.
 - C. For additional information on the PowerPAD™ package and how to take advantage of its heat dissipating abilities, refer to Technical Brief, **PowerPAD Thermally Enhanced Package**, Texas Instruments Literature No. SLMA002 and Application Brief, **PowerPAD Made Easy**, Texas Instruments Literature No. SLMA004. Both documents are available at www.ti.com.

PowerPAD is a trademark of Texas Instruments Incorporated.

IMPORTANT NOTICE

Texas Instruments Incorporated and its subsidiaries (TI) reserve the right to make corrections, modifications, enhancements, improvements, and other changes to its products and services at any time and to discontinue any product or service without notice. Customers should obtain the latest relevant information before placing orders and should verify that such information is current and complete. All products are sold subject to TI's terms and conditions of sale supplied at the time of order acknowledgment.

TI warrants performance of its hardware products to the specifications applicable at the time of sale in accordance with TI's standard warranty. Testing and other quality control techniques are used to the extent TI deems necessary to support this warranty. Except where mandated by government requirements, testing of all parameters of each product is not necessarily performed.

TI assumes no liability for applications assistance or customer product design. Customers are responsible for their products and applications using TI components. To minimize the risks associated with customer products and applications, customers should provide adequate design and operating safeguards.

TI does not warrant or represent that any license, either express or implied, is granted under any TI patent right, copyright, mask work right, or other TI intellectual property right relating to any combination, machine, or process in which TI products or services are used. Information published by TI regarding third-party products or services does not constitute a license from TI to use such products or services or a warranty or endorsement thereof. Use of such information may require a license from a third party under the patents or other intellectual property of the third party, or a license from TI under the patents or other intellectual property of TI.

Reproduction of information in TI data books or data sheets is permissible only if reproduction is without alteration and is accompanied by all associated warranties, conditions, limitations, and notices. Reproduction of this information with alteration is an unfair and deceptive business practice. TI is not responsible or liable for such altered documentation.

Resale of TI products or services with statements different from or beyond the parameters stated by TI for that product or service voids all express and any implied warranties for the associated TI product or service and is an unfair and deceptive business practice. TI is not responsible or liable for any such statements.

Mailing Address:

Texas Instruments
Post Office Box 655303
Dallas, Texas 75265